

User Manual

bidirectional Multifunctional-Counter

7 7 x
tico
HENGSTLER

English



Part-No. 2 772 083 english; 05/2011
Original language German
English translated from German

HENGSTLER

1	General Information	7
1.1	Information about the Operating Instructions	7
1.2	Explanation of symbols	8
1.3	Limitation of Liability	9
1.4	Copyright protection	10
1.5	Guarantee conditions	10
1.6	Customer Service	10
2	Safety	11
2.1	Intended Use (Proper Use)	11
2.2	Assembly, connecting, programming	12
2.3	Responsibilities of the machine/plant manufacturer and operator	14
2.4	Staff-related requirements	15
2.5	Special hazards	16
2.6	Safety devices	17
3	Setup and Operation	18
3.1	Dimension Sheet / Multifunction Counter Installation	19
3.2	Connecting the Multifunction Counter	19
3.3	Display	21
3.4	Keyboard functions	22
3.5	Overview of Operating Elements	24
3.6	Programming the Standard Function	25
3.7	Programming the Function Codes	26
3.8	Programming the Preset Modes	27
3.9	Prescaler Programming	29
3.10	Programming the (User) Times	30
3.11	Output of ID Data	31
3.12	Adjusting the intensity of the backlight	32

Table of Contents

4	General Description of Multifunctional Counter	33
5	Pulse Counter	38
5.1	Description of Pulse Counter	38
5.2	Signal diagrams – counter input signals	39
5.3	Signal diagrams – counter output signals	41
5.4	Programming the counter function codes	43
6	Tachometer	55
6.1	Tachometer description	55
6.2	Signal diagrams – tachometer	56
6.3	Programming the tachometer function codes	57
7	Timer	66
7.1	Timer description	66
7.2	Signal diagram – timer input signals	68
7.3	Signal diagrams – timer output signals	69
7.4	Programming the timer function codes	70
8	Shift Counter	83
8.1	Shift counter description	83
8.2	Scroll between Total Sum and Partial Sums	84
8.3	Signal diagrams – shift counter input signals	84
8.4	Signal diagrams – shift counter output signals	85
8.5	Programming the shift-counter function codes	86
9	Batch Counter	97
9.1	Batch counter description	97
9.2	Signal diagrams – batch counter	98
9.3	Programming the batch counter function codes	98

Table of Contents

10	Technical Data	111
11	Transport, Packaging, Storage	118
12	Maintenance and cleaning	118
13	Malfunctions	119
14	Spare Parts	121
15	Dismantling and Disposal	121
16	Ordering Information	122
17	Accessories and spare parts	123

1 General Information

1.1 Information about the Operating Instructions

These operating instructions provide important information about the handling of the multifunctional counter. To ensure safe operation it is vital that the safety information and instructions be strictly observed.

For Counters with interfaces Tico 773 and Tico 774 please see the amendment 0 773 001

The multifunctional counter has been designed for industrial use and for installation in machinery or industrial plants.

The manufacturer of the machine/plant in which the multifunctional counter is used has to ensure that the function of the counter is properly described in the Operating Instructions of the machine or plant, and that the description is in accordance with manufacturer's programming functions.

The manufacturer's safety rules shall be applicable.

In addition, the local regulations concerning the prevention of accidents and general safety information applicable to the machinery/plant shall be adhered to.

Before starting any work on the machine/plant, the operating instructions and in particular, the Safety chapter and the respective safety information must be fully read.

These operating instructions are an integral part of the product and must be maintained in the direct vicinity of the machine/plant and in a place that is readily accessible for the operating staff.

These operating instructions contain important information concerning the installation, connection and programming of the multifunctional counter.

General Information

Description of the programming sequence:

- Programming of the basic functions
- Programming of the function codes
- Programming of the user times
- Programming of the prescaler
- Programming of the presettings

Before starting to run the machine/plant, all functions that are not allowed to be changed by the operator have to be blocked.



The executed programming functions have to be documented.

1.2 Explanation of symbols

The warnings in these operating instructions are designated by symbols. Signal words at the beginning of the warnings indicate the severity of a safety hazard.

These notes have to be observed by all means, and all actions have to be taken with utmost care so as to prevent any accidents or damage or personal injury.



Danger!

This warning indicates a direct safety hazard, which may lead to serious injuries or even death if preventative action is not taken.



Warning!

This warning indicates a possible safety hazard, which may lead to serious injuries or even death if preventative action is not taken.

General Information



Caution!

This warning indicates a possible safety hazard, which may lead to minor damage or injuries if preventative action is not taken.



Note!

This symbol indicates a potentially hazardous situation, which may lead to damage to property or to the environment if preventative action is not taken.



Tips and recommendations

This symbol is used to point out to useful tips and recommendations and information ensuring efficient and trouble-free operation.

1.3 Limitation of Liability

The information and notes contained in these operating instructions were gathered in accordance with the applicable standards and regulations, the state-of-the-art, as well our long-standing experience and know-how.

The manufacturer shall not assume any liability for damage caused by:

- Non-adherence to the operating instructions
- Improper use
- Employment of unskilled or untrained personnel
- Makeshift changes or manipulation
- Opening of the multifunctional counter

As a result of special design versions, special ordering options or the latest technical developments, the actual scope of delivery may deviate from the scope described and illustrated here.

1.4 Copyright protection

The operating instructions must be treated confidentially and used exclusively by the personnel responsible for the setup, maintenance, repair and operation of the machine/plant. Disclosure of these operating instructions to any third parties shall not be permissible without the prior written consent of the manufacturer.



The data and information stated here, including text, drawings, images and other illustrations, are protected by copyrights and subject to industrial property rights. Any misuse of such information shall be subject to prosecution.

1.5 Guarantee conditions

Our guarantee conditions are available for download from our homepage at www.hengstler.com – DOWNLOAD – General Terms & Delivery Terms.

1.6 Customer Service

Our customer service is available to provide technical information and assistance for our customers. Detailed information on your responsible contact partner is given on our homepage (www.hengstler.com) under Contact and How to find us.

2 Safety

This section provides an overview of all the important safety-relevant aspects to ensure best possible protection of the operating personnel as well as safe and trouble-free operation. Non-adherence to the instructions given in this manual may result in considerable safety hazards.

2.1 Intended Use (Proper Use)

The multifunctional counter is exclusively designed and constructed for the intended use and purposes described here.

The multifunctional counter serves together with a corresponding sensor for the counting of piece numbers, lengths, flow rates, velocities and times, as well as for the controlling and monitoring of machinery and equipment by sending control signals.



Warning!

Safety hazards due to improper use / misuse! Using the multifunctional counter for any purposes other than the ones described within the scope of intended use may cause hazardous situations. Claims for damages resulting from any kind of misuse shall be expressly excluded.

2.2 Assembly, connection, programming

These multifunctional counters are built and tested in accordance with IEC/EN 61010-1, Protection Class II – Safety Measures for Electronic Measuring Equipment. They have left the factory in a condition that is in compliance with all safety-relevant requirements. In order to maintain this condition and ensure operational safety, the User is requested to observe the safety notes and warnings given in these operating instructions!



Danger!

Risk of safety hazards due to incorrect/faulty assembly and connection.

- The max. operating voltages must not be exceeded!
- 12 – 24VDC and 24VAC multifunctional counters have to be operated at safety extra-low voltages (SELV) and under potential-compensated conditions in order to prevent hazardous shock currents.
- An external fuse has to be provided to protect the multifunctional counter (see Chapter 10, Technical Data).
- Installation and assembly shall be carried out by skilled and trained electricians only.
- Do not connect the multifunctional counter without making sure that it no longer carries any live voltages. Always separate it from the mains supply before connecting.
- Make sure that live terminals are properly protected against inadvertent contact.
- To ensure proper protection of terminals against hand contact, make sure that the live conductors are properly connected to the terminals.
- It's not allowed to use the multifunctional counter outside of the specified temperature range. If necessary appropriate precautions have to be applied

(e.g. air ventilation). • The rules and regulations set forth by the local electricity providers have to be observed.

- Do not establish any connections with non-allocated (NC) terminals.
- Multifunction counters may only be operated in a properly installed condition.
- If safe operation seems to be impaired, make the multifunctional counter inoperable and secure it against inadvertent operation.
- Scope of applications: industrial processes and controls. Overvoltage across the terminals must be limited to the values of overvoltage category II.
- The installation and wiring environment has considerable impact on the electromagnetic compatibility of the multifunctional counter. Therefore, electromagnetic compatibility of the entire plant has to be ensured during the installation.
- In areas presenting the risk of ESD (electrostatic discharge), make sure to use ESD-protected plugs and switches during the installation.
- If the functions "prescaler input", "preset input" and "key reset" are not allowed to be used by the machine/plant operator, access to these functions must be blocked for machine operators. Depending on the machine/plant design or concept, non-permissible input may impair the operational safety and function of the machine or plant.



Danger!

The manufacturer of the machines / plants has to ensure, that no risks result from this.

- The machine/plant manufacturer shall be responsible for the preparation of operating instructions / plant description including the following:

- Description of functions according to the programming of the multifunction counter;
- Description of the settings to be adjusted by the machine/plant operator;
- Information concerning the occupational safety requirements and possible hazards arising from the operation of the machine/plant.

2.3 Responsibilities of the machine/plant manufacturer and operator

Multifunctional counters are designed for installation in machines/plants. Therefore, the manufacturer and operator of the machine/plant are subject to the legal obligations concerning occupational safety and health.

Besides the safety notes given in these operating instructions, the relevant rules and regulations concerning safety and the prevention of accidents, and the applicable environmental requirements have to be met. In particular:

- The machine/plant manufacturer shall be obligated to ensure that all the requirements mentioned in section 2.2 be fulfilled during the assembly, connection and programming.
- The operator shall obtain all the required information about the applicable occupational safety rules. In addition, the operator shall be obligated to prepare a risk assessment of possible hazards that may arise due to the special working conditions at the place of installation of the machine/plant. This risk assessment shall be documented in the form of operating instructions for the machine/plant.
- Throughout the entire operating time of the machine/plant the operator shall be obligated to check if the operating instructions prepared are in accordance with the latest status of requirements and, if required, make the appropriate adjustments.

- The operator shall ensure that all staff members who are involved in the machine/plant operation have read and fully understood these instructions. Moreover, the operator shall be obligated to train the operating personnel at regular intervals and inform them about any potential hazards.
- The operator shall ensure that the operation and cleaning of the machine/plant is exclusively carried out by skilled and trained personnel.
- The operator shall ensure that all maintenance and repair work shall only be carried out by skilled and trained personnel.

2.4 Staff-related requirements



Warning:

Danger of personal injuries if handled by insufficiently qualified staff! Improper handling may cause severe personal injuries and damage to property.

- Actions requiring special skills have to be carried out only by the personnel designated in the appropriate sections of these instructions.
- Keep unqualified personnel away from hazard areas.

The following staff qualification requirements have been defined for the various scopes of activities:

- **Instructed personnel**
These persons have been instructed by the operator with regard to the tasks assigned and the potential hazards caused by improper handling.
- **Skilled personnel**
Due to their educational and professional skills, know-how and experience, as well as due to their knowledge of the relevant regulations, these persons are capable of executing their assigned tasks and recognize potential hazards independently.

• Skilled and trained electricians

Due to their educational and professional skills, know-how and experience, and due to their knowledge of the relevant regulations in the field of electrical engineering, these persons are capable of executing electrical work and recognizing potential hazards independently.

2.5 Special hazards

This section indicates certain residual risks, which may arise as a result of the risk assessment.

The safety information and warnings given here and in the following chapters of these instructions have to be observed in order to reduce any health hazards and avoid hazardous situations.



Electric current

Danger!

Lethal hazard of electric shock!

Any contact with hazardous live components presents a direct lethal hazard.

Damages of the insulation or individual components present a potential lethal hazard.

- In the event of any damage to the insulation, immediately disconnect the voltage supply and initiate the appropriate repair work.
- Any work on the electrical plant has to be carried out by skilled and trained electricians only.
- Before commencing your work on the electrical system, disconnect it from the main supply and check that it no longer carries any live voltages.

- Prior to conducting any maintenance, cleaning or repair work, disconnect the mains supply and secure it against inadvertent switching on.
- Do not short-circuit or make fuses inoperable.

2.6 Safety devices



Warning! Lethal hazard by non-functional safety devices! Safety devices are provided to ensure a maximum of operational safety.

The multifunctional counter itself does not include any installed safety devices.

These safety devices have to be attached externally.

Protect the electrical supply of the multifunctional counter by means of external fuses (see Chapter 10, Technical Data).

Whether or not additional safety devices (e.g. emergency-off buttons) have to be provided depends on the general design and construction of the machine or plant.

The machine/plant manufacturer shall be responsible for providing such additional safety devices in according with his own risk assessment.

3 Setup and Operation

- 1 Display
- 2 Operating keys
- 3 Flat gasket
- 4 Bracket
- 5 Enclosure
- 6 Plug for DC or sensor supply;
Electronic inputs and outputs
- 7 Connection terminal AC supply and relay contacts
- 8 Circuit diagram



3.1 Dimension Sheet / Installation of Multifunction Counter

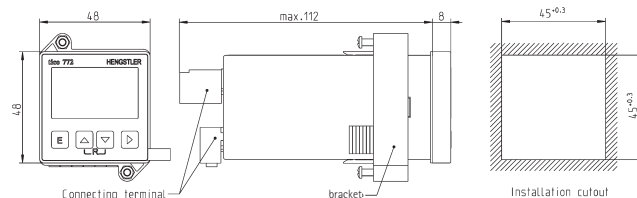

3.2 Connecting the Multifunction Counter

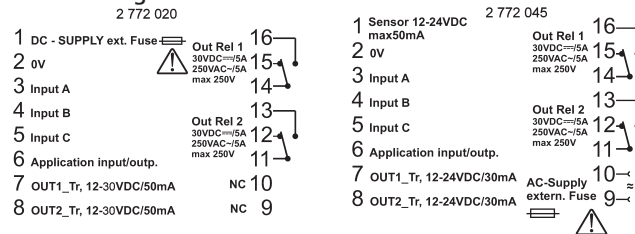

VDC 2 relays / 2 transistors

VAC Trafo 2 relays / 2 transistors

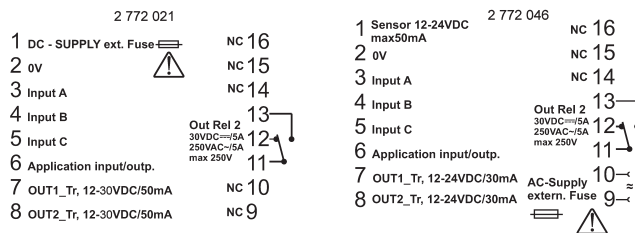

VDC 1 relay / 2 transistors

VAC transformer 1 relay / 2 transistors

Setup and Operation

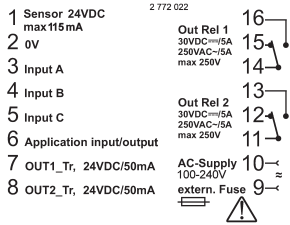

VAC switching power supply
2 relays / 2 transistors

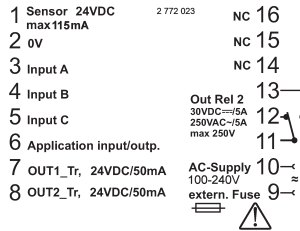

VAC switching power supply
1 relay / 2 transistors



The plug has to be disconnected from the counter before the cables are fastened by means of screws or screw-type terminals.



It is not allowed to contact the encoder to a direct current line voltage without protective circuit for EMC. For cable lengths > 30 m a protective circuit is always necessary!

When programming the input level to TTL an additional protective circuit is necessary.

We recommend the installation in an metallic environment.

Setup and Operation

Only valid for DC-Versions:

When switching on the device in PNP-Mode, a short signal is applied to inputs A,B,C and the application input.

To suppress the pulse in TTL-Mode each input has to be connected to a resistor of 10 kOhm/0,125W against 0V.

When switching on the device a short signal is applied to the application output.

This pulse, if needed, is possible to suppress by connecting a resistor of 10 kOhm / 0,225 W against 0 V to the application-output.

3.3 Display

After switching on, all segments and characters are illuminated for approx. 2 seconds; then the display changes over to the Display or Programming Mode.



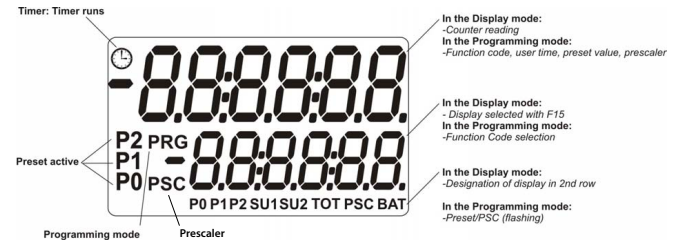

The display is available in five different versions:

- Reflectiv: black figures on bright reflecting background
- Transflective positive: black figures on back lighted ground
- Transmissive white: white figures on black ground
- Transmissive red: red figures on black ground
- Transmissive green: green figures on black ground











Setup and Operation

During the Programming of Function Codes



			
Enter - Key	UP - Key	Down - Key	SHIFT - Key

Programming











If pressed together with POWER ON (keep keys pressed and switch on the device)

 + 	Selects standard functions
 + 	Sets function codes
 + 	Selects ID data (Article code (ID No.), manufacturing date, serial number,...)
 + 	Sets User Times

During the Programming of Function Codes

 + 	Display of function code Switches between function code text and function code number
----------------------------------------------------------------------------------------------------------------------------------------------------------------------	------------------------------------------------------------------------------------------

During Operation



 + 	Reset
 + 	Sets preset 0
 + 	Sets preset 1
 + 	Sets preset 2
 + 	Sets prescaler

Setup and Operation





Additional function for shift and batch counters

	Switches between total sum and partial sums and/or count value and totalizer or batch counter
-----------------------------------------------------------------------------------	-----------------------------------------------------------------------------------------------

Additional function for timers

	Timer start (If enabled with function code F15)
	Timer stop (If enabled with function code F15)

Additional function backlight versions

	Go to the adjustment menu (pressing > 5 s)
 + 	Adjustment of the intensity (brighter or darker)
	Save and going back to display mode (Pressing within 15 s)

Setup and Operation

3.5 Overview of Operating Elements

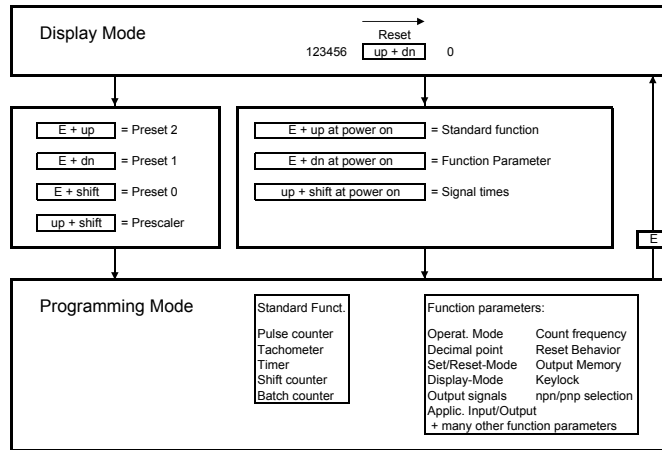

Setup and Operation

3.6 Programming the Standard Function

The device described here is a multifunctional counter, which can be programmed for a variety of functions, i.e. pulse counter, tachometer, timer, shift counter or batch counter functions. The first step is to set the standard function (the factory setting of the device is the "pulse counter" setting).

Now continue with the programming of the function codes (Chapters 5-9) or User Times (Chapter 3.10)

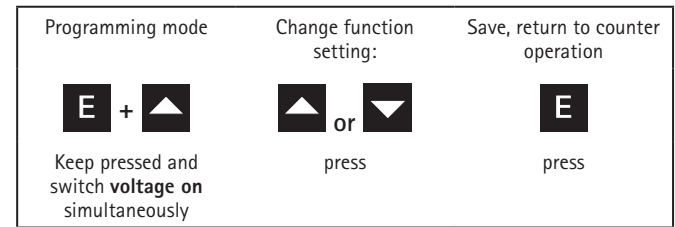







Function code Fn, Display Row 1 **FUNC** 0

Function	No.	Display Row 2	
Setting of Standard Function	0*	PULSCE	Pulse counter
	1	TACHD	Tachometer
	2	TIMER	Timer
	3	SHIFCE	Shift Counter
	4	BATCHC	Batch Counter

Setup and Operation

3.7 Programming the Function Codes

The function codes (system parameters) are used to program the function and behavior of the inputs and outputs, as well as the behavior of the device in its adjusted basic mode. The detailed selection options are described in Chapters 5 to 9.

Programming mode	Change function setting	Save and change to next function code	Save and change to counter operation
 + 	 or 		
Keep pressed and switch voltage on simultaneously	press	press	press

Change between Text Display and Numerical Display



In the function code Programming Mode, the first row shows the name of the function code in the form of text (7-segment display). The second row shows the selectable option in a text form, too. By simultaneously pressing the Up and Down buttons, the display in the first row changes to a numerical display; after pressing these buttons once again, the display in the second row also changes to a numerical display. Pressing these buttons for a third time reverts both rows to the text display again.

Setup and Operation



Attention: With each change among text and numeric display, the currently activated function code will return to the factory setting and may have to be readjusted.

The factory setting is designated with an asterisk *.

3.8 Programming the Preset Values

By simultaneously pressing the E + Up, E + Down or E + Shift key you can change to the Preset programming mode:

Use the shift key in the programming mode to change a setting position. The selected position will start to flash. Use the shift key again to move by one position to the right. Then use the UP or Down key to increment or decrement the position by 1.

Rule for the 6th position: The change from 9 to 0 or 0 to 9 is indicated by a changing prefix.











Use the E key to leave the programming mode and return to the display mode. Your entries will be saved.

On leaving the programming mode, the presets are tested for attainability and recalculated, if necessary, because not all the values may be attained at a prescaler value of >1. The presetting is then rounded to the next attainable value.

If no key is pressed for more than 16 seconds in the programming mode, the counter will automatically return to the display mode. In this case, however, no entries will be saved except the last value saved with the E-key.

Set the preset value to 0 by pressing Up and Down keys simultaneously.

Setup and Operation

Programming mode	Position flashes:	Set position:	Save and return to display mode
 Preset 2	 press	 or  press	 press
 Preset 1		 + 	Zero in
 Preset 0		 Set Preset	

Setup and Operation

3.9 Prescaler programming

By pressing the Up + Shift keys simultaneously you can change to the Prescaler Programming Mode.







In the Programming mode, the position to be changed is selected by means of the shift key. The selected position will start flashing. Use the shift key again to move by one position to the right. Then use the UP or Down key to increment or decrement the position by 1. It is not possible to save a value of 00,0000. In this case the system will save 01,0000.

Use the E key to leave the programming mode and return to the display mode. Your entries will be saved.

On leaving the programming mode, all the presets are recalculated because not all the values may be attained with a prescaler value of >1. Therefore, the presets have to be checked and corrected as necessary after saving the prescaler.

If no key is pressed for more than 16 seconds in the programming mode, the counter will automatically return to the display mode. In this case, however, no entries will be saved except the last value saved with the E-key.

Press the Up and Down keys simultaneously to set the prescaler to 01,0000.

Programming mode	select a position: (starts flashing)	Set position	Save and return to display mode
 press	 press	 or  press	 press
		 Set prescaler	
	set to 01,0000		

Setup and Operation

3.10 Programming the user times

For programming the signal time for monostable output signals, 9 fixed signal times between 0.02 s and 10 s are available. In addition, three different signal times between 0,01s and 599,99s can be set by the user. The outputs are deactivated if the setting is 0.00 s.

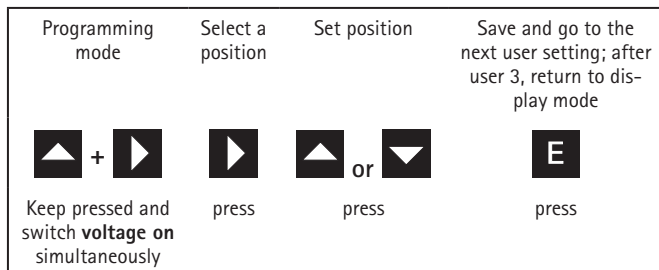

Function code Fn, Display-Row 1 

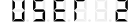
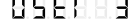



Function	No.	Display Row 2
Sets the Signal Times	0*	 Signal time 1
	1	 Signal time 2
	2	 Signal time 3

Setup and Operation

3.11 Output of ID data

This function is used to retrieve ID data, e.g. article numbers and various manufacturing data.



Display row 1	Display row 2
	Article number
	Manufacturing date
	Serial number
	Software number
	Software release

Setup and Operation

3.12 Adjusting the intensity of the backlight

For counters that come with a backlight you have the possibility to adjust the intensity of their backlight.

To get into the menu of the adjustment, you have to press SHIFT for more than 5 seconds. The display then shows:



By pressing the UP or DOWN key the display gets brighter or darker.

If the E-button is pressed within 15 s, you go back to the normal counter display and the adjusted setting is saved. If the E-button is not pressed within 15 seconds, you will go back automatically to the normal counter menu without saving any made changes.

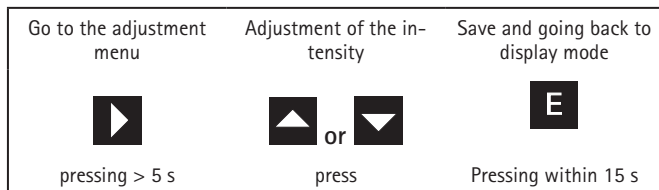

General description of multifunctional counter

4 General description of multifunctional counter

The following description is applicable for all standard settings. Special descriptions can be found in the appropriate chapters of this manual.

Factory setting (Defaults)

Sets all the function codes to the factory settings, i.e. all codes designated with *.

Prescaler (pulse metering factor):

The "Prescaler" is a multiplier. Each input pulse is multiplied by the adjusted factor. The display shows integers only. After a reset the counter is completely reset to 0; this also includes the non-visible value of < 1.

At a prescaler of >1 not all the values are selectable. If invalid Preset values are selected, the counter will round them up to the next possible value.

Example: PSC 5 cannot select (reach) Preset value 7. In this case, the counter automatically changes the Preset value to 10).

If the Prescaler is changed, this may also affect the Preset values, which may have to be changed accordingly.

Adjusting range 0,0001 to 99,9999

The Prescaler is used, for example, to convert counter pulses into meaningful units, to adapt the units of measurements (e.g. cm-pulses to inch-pulses), or to compensate for worn out measuring wheels.

Formula: $PSC = \text{Desired/nominal display} / \text{number of pulses}$

Example: Flowmeter 173 pulses per 100 liters; display in liters

$$PSC = 100 / 173 = 0,5780$$

Example: 1 pulse per cm; display in inch

$$PSC = 1 / 2,54 = 0,3937$$

General description of multifunctional counter

Attention: This is only valid for counters and tachometers.
For timers please refer to the special Timer Description.

Display 2. row:

The display of the 2nd row can be programmed as follows:
P 2, P 1, P 0, Prescaler, Batch counter, totalizer or partial sums
(shift counter)

Counter and control inputs:

The counter is fitted with 3 counter and control inputs and, in addition, with an application input (see below). These inputs are assigned various counter or control functions by means of function code settings

Input logic:

The input logic can be programmed to NPN or PNP, each at the 8V-level or TTL level; see Technical Data for the switching threshold.

Reset/Set:

Manual setting via keys (lockable)
Electronic setting via control input (and/or application input)
Automatic programming after reaching the main Preselection
Programmable Power-On Reset

Depending on the function code the counter is:

1.) Reset: reset to 0

P 2 is the main Preset (preselect) value

During unidirectional counting the counter will add up.

or

2.) Set: reset to P 2

Signal 2 at 0

During unidirectional counting the counter will subtract.

For time counting, batch counting or shift counting, it is possible to reset partial sums or the total sum, batch counter or 2nd totalizer individually or at the same time via the application input.

General description of multifunctional counter

Independently the counter can be reset to Preset value 0 via the application input (see below).

Exception: Tachometers do not have a reset/set function

Static/dynamic reset:

Static reset: Reset over the entire pulse width of the reset pulse

Dynamic reset: Reset via the active edge; thereafter, counter operation is possible independently of the pulse width of the reset pulse.

Exception: Tachometers do not have a reset/set function

Teach input:

Using the Teach Input (application input) the counter status is imported in Preset 2.

Decimal Point:

The decimal point is only an optical reading assistance on the display and does not change the value. For example, for a value of 1 pulse per cm, the setting 0,00 makes it easier to read the value in m and cm.

Exception: This does not apply to tachometers and timers.
Please refer to the detailed Tachometer and Timer descriptions.

Input damping (Attenuation)

The inputs A and B are limited to 60 kHz.

The Application Input is limited to 6 kHz.

Following maximum input frequencies are not to be exceeded:

Phasediscriminator single evaluation: A and B each 30 kHz (TTL 15 kHz)

Phasediscriminator double evaluation: A and B each 30 kHz (TTL 15 kHz)

Phasediscriminator quadruple evaluation: A and B each 15 kHz (TTL 15 kHz)

Unidirectional counting and directional input: Input A 60 kHz (TTL 15 kHz)

Differential counting, summation (totalizing): Input A + B 60 kHz (TTL 15 kHz)

General description of multifunctional counter

When the application input is used as an additional count input, the above mentioned input frequencies have to be reduced by the frequency of the application input:

If mechanical contacts are triggered (i.e. relays, switches, Reed contacts, etc.), the input frequency has to be damped (attenuated) to 30 Hz, so as to filter out bounce pulses.

If damping to 30 Hz is selected, all inputs can be used at 30 Hz.

To reach these values the amplitude thresholds are to be hold.
(See technical data – chapter 10)

Signal

P 1 and P 2 are available as relay changeover contacts and electronic output signals (PNP).

P 0 is available as an electronic output signal across the application output (PNP).

If a signal is active, this will be shown on the LCD display.
Optionally, the multifunctional counter can be set to have the display flash if one or all the preset values are active.

This is also valid for Preset 0 (if no output has been assigned)

Signaltime:

1.) bistable: Cleared by electronic or manual reset.

P 0 + P 1 = bistable – additionally cleared by signal 2

Attention: Signal 2 must not be bistable for automatic reset.

2.) monostable: Up to 9 fixed signal times are available between 0,02s and 10s. In addition, user times can be programmed between 0,01s to 599,99s.

3.) Range signals: active as long as the counter reading is within the adjusted range.

Signals active on/off

During normal operation the relay is energized if the signal is active.

This behavior can also be inverted (also applicable to the transistor outputs).

General description of multifunctional counter

Application input/output:

Depending on the standard function, up to 11 (eleven) functions can be assigned to the application input/output. Note, however, that only one of these functions can be selected.

Further details are given in the Function Code Chapter.

Application – Set to preset 0

Programs the application input to act as a Set Input. The counter is set to Preset 0, independently of the reset via input C or the keyboard.

This function is not available for tachometers.

Application keylock:

All keyboard functions can be locked (latched) individually (Reset, P 0, P 1, P 2, Prescaler)

Lock mode: release after 10s, complete keylock or keylock depending on keylock input (application input)



Our advice! After setting up the system, lock (latch) all the keyboard functions that are not allowed to be changed by the user.

5 Pulse Counter

5.1 Description of the Pulse Counter

(Supplementing the General Description in Chapter 4)

Counter mode:

The following counter modes can be selected:
Unidirectional counting, adding or subtracting;
Unidirectional counting with directional input;
Differential counting, summation (totalizing) or
phase discriminator (quad) with single, double or quadruple evaluation.

Output signals mode of operation:

1.) **coincidence signal:** The counter operates in the coincidence mode, i.e. output signals are activated after reaching the Preset value for the programmed period of time.

2.) **Trail:** P 2 and P 0 are under coincidence operation; they operate as described in item A.
P 1 is the trail. P 1 is not absolute to 0, but relative to P 2.

If the setting is F8=1, the following will apply:
Signal 1 is returned at P 2 - P 1
Example: P 2=1000, P 1=200, Signal 1 at 800;
If P 1 is negative: P 2=1000, P 1=(-200), Signal 1 at 1200

If the setting is F8=2, the following will be applicable:
Signal 1 is returned at P 2 + und - P 1
(Example: P 2=1000, P 1=200, Signal 1 at 800 or/and 1200)

3.) **range signal:** VW 1 and 2 are range signals:
Signal 1 is active at a counter reading < P 1 and
Signal 2 is active at a counter reading > P 2

Intermediate cut:

Depending on the application it may become necessary to isolate the main signal during the reset, e.g. when the first material lengths or certain lengths showing material defects have to be cut on length-cutting systems.

Additional totalizer (summation counter)

The additional totalizer sums up all values, even if the main counter is continually reset. The shift key can be used to switch between the counter reading and the total sum. The totalizer can only be reset manually.
To do this, select the total sum from the first row; then press the reset keys.

Prescaler Output PSC-out:

The prescaler output is an application output.
With each increase of the counter reading the number of output pulses corresponds to the respective number of increments.

The pulse length of the prescaler output corresponds to a frequency of 500 Hz.

When using the prescaler output the max. count frequency is:

$$F \text{ max} = 500 / \text{PSC.}$$

So it is possible that the maximum input frequency can not be reached.

Application counter input add / sub

The application input may be assigned to the Count Up or Count Down function.

This is a counter input, which is available in addition to the counter mode adjusted with F1.

Application Latch/Reset

Latch/Reset is an application input. If the counter is reset via the application input, the counter reading is held constant. The counter continues to remain fully functional and operates in the background mode. During the next reset the current (updated) value will be shown on the display.

5.2 Signal diagrams input signals (PNP-Logic)

Unidirectional counting (F1 = C G r) = 0

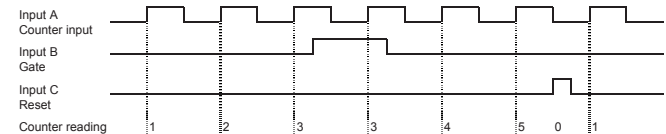

Pulse counter

Directional input (F1= C d r) = 1

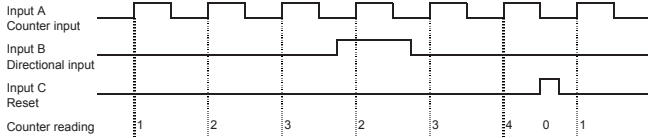

Differential input (F1= A S r) = 3

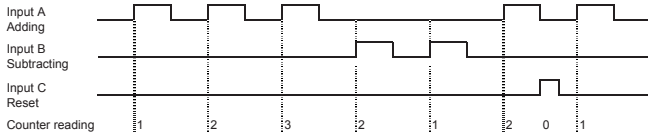

Summation (totalizer) input (F1= A A r) = 5

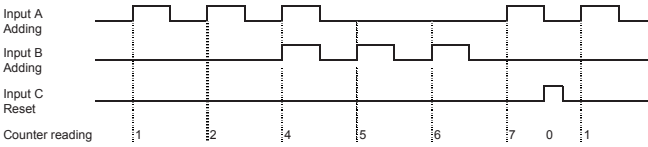

Phase discriminator (F1 = QUAd r) = 6

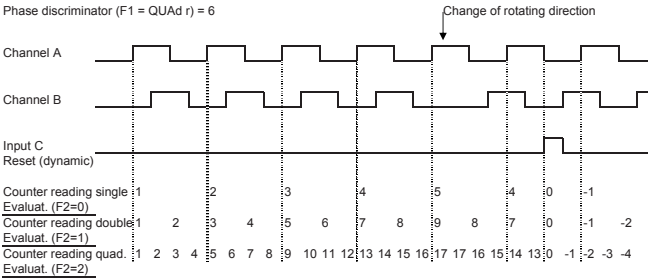

Pulse counter

5.3 Signal diagrams - Output signals

Output signals monostable
Coincidence signals P 0 (F10), P 1 (F11), P 2 (F12) monostable

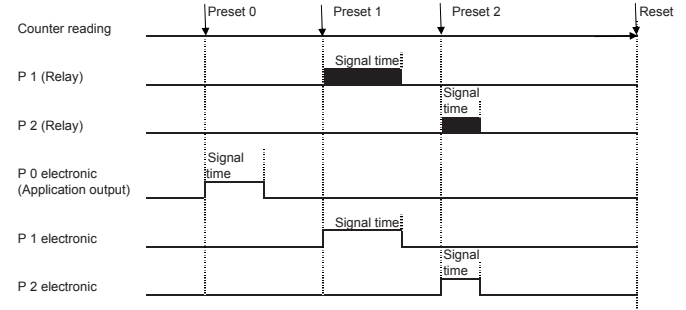

Output signals bistable
Coincidence signal time P 0 (F10) monostable P 1 (F11), P 2 (F12) bistable

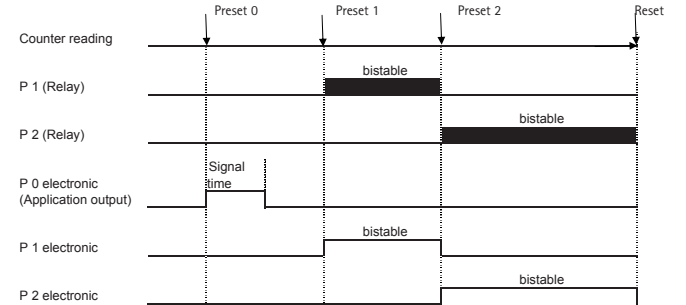

Pulse counter

Trail Preset
 P 0 (F10) Coincidence signal monostable, P 1 (F8+F11) trail signal, symmetrical,
 P 2 (F12) Coincidence signal monostable

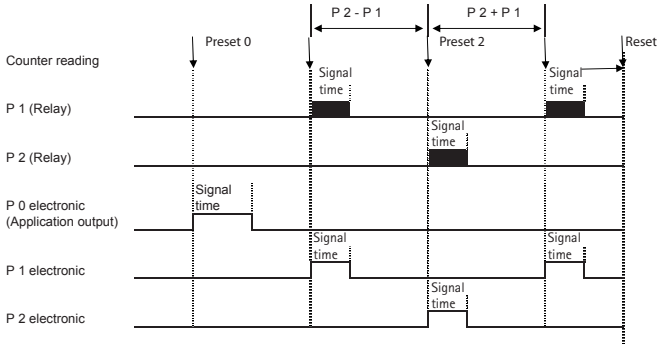

Range signals
 P 0 (F10) Coincidence signal monostable P 1 + P 2 range signal

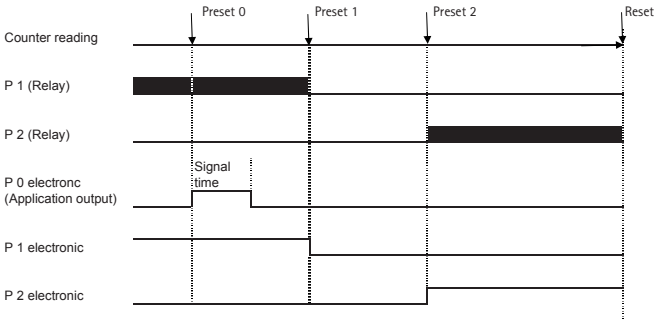

Pulse counter

5.4 Programming the counter function codes

Program- ing mode	Change function setting	Save and change to next func- tion	Return to display mode
E + ▼	▲ or ▼	▶	E
Keep pressed and simultaneously turn Voltage On	press	press	press
Alternative display of function codes	▲ + ▼	The function codes are displayed as text in row 1. By pressing both keys simultaneously you can change to the numerical display (F 0 to F 35). After pressing these keys once again the number of the selectable options will be displayed in addition. This setting will be stored.	

Function code F0, Display Row 1: F C E S E E

Function	No.	Display Row 2
Factory Setting (Defaults)	0*	8888 0 No Function
	1	888 4 E S All Function Codes are set to the values marked with *

Pulse counter

Function code F1, Display Row 1: C O U N T E R

Counter Mode	0*	Input A	Input B	Input C
	000000	Count. inpt.	Gate	Reset
1	000001	Count.inpt.	Direction. Input	Reset
2	000002	Count.inpt.	Direction. Input	Gate
3	000003	Adding	Subtracting	Reset
4	000004	Adding	Subtracting	Gate
5	000005	Adding	Adding	Reset
6	000006	Channel A	Channel B	Reset
7	000007	Channel A	Channel B	Gate

Function code F2, Display Row 1: Q U A D R A T

Edge Evaluation /Quadrat. evaluation	0*	000001	Single evaluation
	1	000002	Double evaluation
	2	000004	Quadruple evaluation

Pulse counter

Function code F3, Display Row 1: I N P L O G

PNP/NPN-Logic	0	000000	NPN-8V-Level
	1*	000001	PNP 8-V Level
	2	000002	NPN TTL-Level
	3	000003	PNP TTL-Level

Function code F4, Display Row 1: I N T E R

Input-damping (Attenuation)	0	000000	30 Hz damping (e.g. for mechanical contacts)
	1*	000001	F max. (see chapter 4 and 10)

Function code F5, Display Row 1: P R E S E T

Set / Re-set- Mode	0*	000000	Reset to 0
	1	000001	Automatic reset to 0 after reaching Preset 2
	2	000002	Set to Preset 2
	3	000003	Automatic set to Preset 2 after reaching 0

Pulse counter

Function code F6, Display Row 1: **RESER**

dynam./ static Reset	0*	SEAE	Static reset (reset as long as the signal is applied)
	1	dYn	Dynamic Reset (ready to count after reset (even if reset signal is applied for a longer time)

Function code F8, Display Row 1: **PRESEN**

Mode Preset 1	0*	PRESEN	P 1 normal preset; absolute to the counter reading (coincidence signal)
	1	EPRI	P 1 as a trail preset with prefix (relative to P 2)
	2	EPRI	P 1 as a trail preset symmetric trail (relative to P 2)
	3	PANGE	P 1 and P 2 as a range signal (Sign.1 < P 1, Sign.2 > P 2)

Function code F9, Display Row 1: **RESER**

Output signal	0*	RESER	Active On
	1	RESOFF	Active Off

Pulse counter

Function code F10, Display Row 1: **SIGSEL**

Signal time P 0	0	DISABL	Disabled / No output signal
	1	BISTAB	Bistable, reset with Preset 2 or Reset
	2	002	0,02 s
	3	005	0,05 s
	4*	010	0,10 s
	5	020	0,20 s
	6	050	0,50 s
	7	100	1,00 s
	8	200	2,00 s
	9	500	5,00 s
	10	1000	10,00 s
	11	USER1	User setting 1 (0-599,99 s)
	12	USER2	User setting 2 (0-599,99 s)
	13	USER3	User setting 3 (0-599,99 s)

Pulse counter

Function code F11, Display Row 1: 510000

Signal time P 1	0	88888888	Disabled / No output signal
	1	88888888	Bistable; Reset with Preset 2 or Reset
	2	8888002	0,02 s
	3	8888005	0,05 s
	4*	8888010	0,10 s
	5	8888020	0,20 s
	6	8888050	0,50 s
	7	8888100	1,00 s
	8	8888200	2,00 s
	9	8888500	5,00 s
	10	8888000	10,00 s
	11	USEF888	User setting 1 (0-599,99 s)
	12	USEF882	User setting 2 (0-599,99 s)
	13	USEF883	User setting 3 (0-599,99 s)

Pulse counter

Function code F12, Display Row 1: 510000

Signal time P 2	0	88888888	Disabled / No Output signal
	1	88888888	Bistable; Reset Cannot be used in conjunction with automatic Reset
	2	8888002	0,02 s
	3	8888005	0,05 s
	4*	8888010	0,10 s
	5	8888020	0,20 s
	6	8888050	0,50 s
	7	8888100	1,00 s
	8	8888200	2,00 s
	9	8888500	5,00 s
	10	8888000	10,00 s
	11	USEF888	User setting 1 (0-599,99 s)
	12	USEF882	User setting 2 (0-599,99 s)
	13	USEF883	User setting 3 (0-599,99 s)

Pulse counter

Function code F13, Display Row 1: P 0 0 0 0

Decimal point	0*	8888.80	No decimal point
	1	8888.00	1 decimal place
	2	888.000	2 decimal places
	3	88.0000	3 decimal places
	4	8.00000	4 decimal places

Function code F14, Display Row 1: FLASH

Display flashes	0*	FLASH	No flashing
	1	8888.P0	Flashes as long as P 0 is active
	2	8888.P1	Flashes as long as P 1 is active
	3	8888.P2	Flashes as long as P 2 is active
	4	P0-1-2	Flashes as long as one P is active

Pulse counter

Function code F15, Display Row 1: 2.8888E

Display in 2nd row	0	8888.P0	Preset 0
	1	8888.P1	Preset 1
	2*	8888.P2	Preset 2
	3	888.P50	Prescaler
	4	888.E8E	Totalizer

Function code F16, Display Row 1: 0.0000E5

Output at Reset (In-term. Cut	0*	8888.n0	Do not activate Preset 2 during Reset
	1	ACTE.P2	Activate Preset 2 during Reset

Function code F17, Display Row 1: P0000E5

Power On (Reset)	0*	n000E5	Restore counter value
	1	888.nE5	Reset at Power On

Function code F18, Display Row 1: 0.0000E0

Output signal Memory	0	888.YE5	Restart signal time after power fail ⚠ output switches
	1*	8888.n0	Do not restart signal time after power fail

Pulse counter

Function code F19, Display Row 1: A d d e e e

Addtl.	0	8888YES	Enabled
Totalizer	1*	8888n0	Disabled

Function code F22, Display Row 1: A P U I N P

Applica. Input/Output	0	P5C000E	Prescaler output
	1	P00000E	Output Preset 0
	2	d0P000E	Directional output
	3*	CnE00UP	Counter input - adding
	4	CnE00dn	Counter input - subtracting
	5	RESETEE	Reset input
	6	GAEE000	Gate input
	7	U000000	Keylock input
	8	Hold000	Hold input (display lock)
	9	EEAEH00	Teach input (count value becomes P 2)
	10	SEEE000	Set input (Set to Preset 0)
	11	LAEE0ES	Latch and Reset (Save display at Reset)

Pulse counter



Should you have a counter with interface, the additional function codes F24 - F27 are described in the separate manual for the interface version.

Function code F30, Display Row 1: E S L 0 E

Lock Reset key	0*	80n000E	Enable keyboard reset
	1	888000E	Keyboard reset locked / delayed

Function code F31, Display Row 1: P 0 S L 0 E

Lock Preset 0	0*	80n000E	P 0 Setting enabled
	1	888000E	P 0 Setting locked / delayed

Function code F32, Display Row 1: P 1 S L 0 E

Lock Preset 1	0*	80n000E	P 1 Setting enabled
	1	888000E	P 1 Setting locked / delayed

Function code F33, Display Row 1: P 2 8 8 0 0

Lock Preset 2	0*	8 8 0 0	P 2 Setting enabled
	1	8 8 8 8	P 2 Setting locked / delayed

Function code F34, Display Row 1: P 5 0 0 0

Lock Prescaler setting	0*	8 8 0 0	PSC setting enabled
	1	8 8 8 8	PSC Setting locked / delayed

Function code F35, Display Row 1: 1 0 0 0 0 0

Lock Mode	0*	1 0 0 0 0 0	10 seconds delay
	1	8 8 0 0 0 0	Completely locked
	2	1 0 0 0 0 0	Lock mode depends on keylock input

6 Tachometer

6.1 Tachometer Description

(Supplementing the General Description given in Chapter 4)

Operation:

A tachometer measures the period (PNP: time from one rising edge to the next one); NPN: time period from a falling edge to the next one), and converts and displays this time in 1/sec or 1/min.

Tachometer Mode of Operation:

The following modes of tachometer operation can be selected:

- Unidirectional counting;
- Unidirectional counting with directional input;
- Differential counting, summation (totalizing);
- Phase discrimination (quad) with single, double or quadruple evaluation;
- Indication of ratio A/B and
- Indication of percentage (A-B) /A in %

Decimal point

Tachometer mode of operation 0-4 (function code F1)

The decimal point only serves for better legibility and does not change the value.

Tachometer mode of operation 5 + 6 (function code F1)

The decimal point is included in the calculation and increases the resolution.

Output signals Mode of operation:

The tachometer uses the following limit values:

P 1 and 2 are limit (range) signals

Signal 1 is active at the displayed value of < P 1 and

Signal 2 is active at the displayed value of > P 2

Signal 0 is active at the displayed value of > P 0; (application output)

Display unit:

Programmable: 1/sec or 1/min

Using the setting 1/min and prescaler 60 the display will show 1/hour.

Min. input frequency:

Programmable 1 Hz or 0.1 Hz.

If two edges do not occur within 1 s or respectively 10s, a value of 0 will be displayed.

Startup suppression:

Programmable Yes/No

During the startup the lower limit signal is suppressed until the lower limit value is exceeded for the first time.

The startup suppression will become active again, if the minimum frequency is fallen below.

6.2 Signal diagram – Output signals

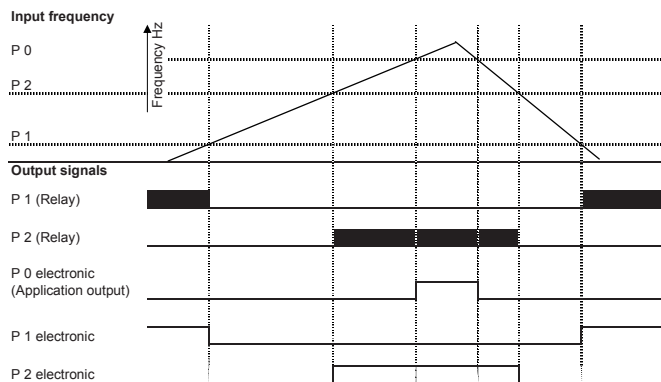

6.3 Programming the tachometer function codes

Programming mode	Change function setting	Save and change to next function	Return to display mode
E + ▼	▲ or ▼	▶	E
Keep pressed and simultaneously turn Voltage On	press	press	press
Alternative display of Function code:	▲ + ▼	The function codes are displayed as text in row 1. By pressing both keys simultaneously you can change to the numerical display (F 0 to F 35). After pressing these keys once again the number of the selectable options will be displayed in addition. This setting will be stored.	

Function code F0, Display Row 1: F 0 E E E E

Function	No.	Display Row 2
Factory Setting (Defaults)	0*	8888 0 0 No function
	1	888 4 E E All function codes are set to the values marked with *

Function code F1, Display Row 1: **COUNT**

Tacho mode of operation	0*	Input A	Input B	Input C
	0*	Count input	Gate	Hold (Display memory)
	1	Count input	Direct input	Hold (Display memory)
	2	Adding	subtracting	Hold (Display memory)
	3	Adding	Adding	Hold (Display memory))
	4	Channel A	Channel B	Hold (Display memory)
	5	Channel A / Channel B		Hold (Display memory)
	6	(A-B) / A in % (Difference in % of A)		Hold (Display memory)

Function code F2, Display Row 1: **QUAD**

Edge Evaluation/Quadrat. evaluation	0*	Single evaluation
	1	Dual evaluation
	2	Quadruple evaluation

Function code F3, Display Row 1: **PNP**

PNP/NPN-Logic	0	NPN 8 V-Level
	1*	PNP 8 V-Level
	2	NPN TTL-Level
	3	PNP TTL-Level

Function code F4, Display Row 1: **ATTEN**

Input damping (Attenuat)	0	30 Hz attenuation (e.g. for mechanical contacts)
	1*	F max. (see chapter 4 und 10)

Tachometer

Function code F5, Display Row 1:000000

Display Unit	0*	PPSEC	Pulse per second (1/sec)
	1	PPMIN	Pulse per minute (1/min)

Function code F6, Display Row 1:000000

Min. Input frequency	0*	000000	1 Hz (if no further pulse is received after 1s, the display will return to 0)
	1	000001	0,1 Hz (if no further pulse is received after 1s, the display will return to 0)

Function code F7, Display Row 1:500000

Startup-suppress.	0	YES	With startup suppression
	1*	NO	Without startup suppression

Function code F9, Display Row 1:000000

Output signal	0*	ON	Active On
	1	OFF	Active Off

Tachometer

Function code F10, Display Row 1:500000

P 0 Addtl. Upper limit	0*	DISABLE	Disabled / no Output signal
	1	ENABLE	Additional range signal > P 0

Function code F11, Display Row 1:500000

P 1 Lower limit	0*	DISABLE	Disabled / no Output signal
	1	ENABLE	Range signal < P 1

Function code F12, Display Row 1:500000

P 2 Upper limit	0*	DISABLE	Disabled / no Output signal
	1	ENABLE	Range signal > P 2

Tachometer

Function code F13, Display Row 1: P 0 P 1 P 2

Decimal place	0*	8888.880	No decimal point
	1	8888.000	1 Decimal place
	2	888.0000	2 Decimal places
	3	88.00000	3 Decimal places
	4	8.000000	4 Decimal places

Function code F14, Display Row 1: F L S H

Display flashes	0*	0 F L S H	Do not flash
	1	8888.P0	Flashes as long as P 0 active
	2	8888.P1	Flashes as long as P 1 active
	3	8888.P2	Flashes as long as P 2 active
	4	P0-1-2	Flashes if one preset is active

Tachometer

Function code F15, Display Row 1: P 0 P 1 P 2

Display in 2nd row	0	8888.P0	Preset 0
	1	8888.P1	Preset 1
	2*	8888.P2	Preset 2
	3	888.P5C	Prescaler

Function code F22, Display Row 1: A P U I N P

Application Input/Output	0	P0-0-0-0-0-0	Output Preset 0
	1	D-0-0-0-0-0	Directional output
	2*	0-0-U-P-0-0	Count input adding, or 2nd count input A
	3	0-0-S-U-0-0	Count input subtracting, or 2nd counter input B
	4	G-A-T-E-0-0	Gate Input
	5	H-O-L-D-0-0	Hold-Input (display memory)
	6	T-E-A-C-H-0	Teach Input (count value becomes P 2)
	7	L-O-C-K-0-0	Keylock-Input



Should you have a counter with interface, the additional function codes F24 – F27 are described in the separate manual for the interface version.

Function code F31, Display Row 1: P 0 8 8 8 8

Lock Pre-set 0 Setting	0*	8 0 8 8 8 8	P 0 Setting enabled
	1	8 8 8 8 8 8	P 0 Setting locked / delayed

Function code F32, Display Row 1: P 1 8 8 8 8

Lock Pre-set 1 Setting	0*	8 0 8 8 8 8	P 1 Setting enabled
	1	8 8 8 8 8 8	P 1 Setting locked / delayed

Function code F33, Display Row 1: P 2 8 8 8 8

Lock Pre-set 2 Setting	0*	8 0 8 8 8 8	P 2 Setting enabled
	1	8 8 8 8 8 8	P 2 Setting locked / delayed

Function code F34, Display Row 1: P 5 8 8 8 8

Lock Prescaler Setting	0*	8 0 8 8 8 8	PSC Setting enabled
	1	8 8 8 8 8 8	PSC Setting locked / delayed

Function code F35, Display Row 1: 1 0 8 8 8 8

Lock Mode	0*	1 0 8 8 8 8	10 seconds delay
	1	8 8 8 8 8 8	Completely locked
	2	1 0 8 8 8 8	Lock mode depends on keylock Input

7.1 Timer Description

(Supplementing the General Description in Chapter 4)

Function:

The timer counts seconds, minutes or hours.

Depending on the resolution (see below) the smallest units to be recorded are 0,1 ms.

Combined with the prescaler (see below), quantities can be measured as a function of time.

Time formats:

4 time formats are available:

Seconds, minutes, hours and HH:MM:SS

Resolution:

By shifting the decimal place, a resolution of up to 4 decimal places can be programmed; the smallest resolution is 0,1 ms.

The time format "seconds with four decimal places" shows 0.1 milliseconds.

The time format "seconds with three decimal places" shows milliseconds.

The time format "minutes with two decimal places" shows 1/100 minutes

Prescaler:

During the timer operation the prescaler has to be disabled or set to 01,0000.

The prescaler can be used to record quantities, provided that the quantity per time unit is known.

Example: A volume of 3 liters per second is supplied.

Settings: Time format "seconds", prescaler 3,0000

Display: Supplied volume in liters as a function of time.

The prescaler cannot be used with the time format HH:MM:SS as it is not active (effective) in this format.

Timer mode of operation:

The following modes of timer operation can be selected:

Cumulative measurement following the pulse-width measuring principle (Cumulative measurement as long as input A is active)

Cumulative measurement following the cycle-duration principle

(Cumulative measurement from rising edge Input A to falling edge of Input A)

Cumulative measurement A=Run, B=Stop (cumulative measurement from rising edge Input A to rising edge Input B)

Single-pulse measurement following the pulse-width measurement principle (Measure as long as Input A is active)

Single-pulse measurement following the cycle-duration principle (Measurement from rising edge Input A to rising edge of Input A)

Single-pulse measurement A=Run, B=Stop (Cumulative measurement from rising edge Input A to rising edge Input B)

Manual Start / Stop via keyboard:

The Start / Stop function can be programmed via the keyboard.

Start: Press the UP button for 0.5s

Stop: Press the DOWN button.

Output signals –Function:

A coincidence signal: The timer operates in the "coincidence" mode, i.e. the output signals are enabled for the programmed period of time after reaching the selected preset value

B trail signal: P 2 and P 0 operate in the "coincidence" mode, i.e. the output signals are enabled for the programmed period of time when reaching the selected preset value. P 1 is a trail preset and not absolute to 0, but relative to P 2.

If the setting is F8=1, the following will apply:

Signal 1 is returned at P 2 – P 1

Example: P 2=1000, P 1=200, Signal 1 at 800;

If P1 is negative: P 2=1000, P 1=(-200), Signal 1 at 1200

If the setting is F8=2, the following will be applicable:

Signal 1 is returned at P 2 + und – P 1

(Example: P 2=1000, P 1=200, Signal 1 at 800 or/and 1200)

C range signal: P 1 and 2 are range signals:

Signal 1 is active at timer reading < P 1 and

Signal 2 is active at timer reading > P 2

Timer

D batch mode: The timer can also be programmed to act as a batch counter. In this case, P 2= main preset value; P 1= Batch preset. In the Batch mode of operation, only positive entries are possible for P1; negative entries will be stored as positive values. This mode is ideal to default a process time and the number of process sequences (runs).

Additional totalizer:

The additional totalizer is used to sum up all the times (even after repeated resetting of the main counter). The totalizer is reset separately.

7.2 Signal Diagrams – Input signals

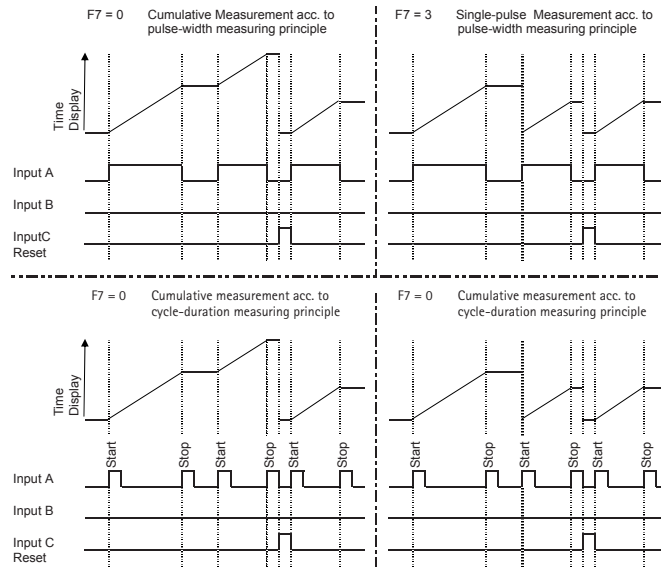



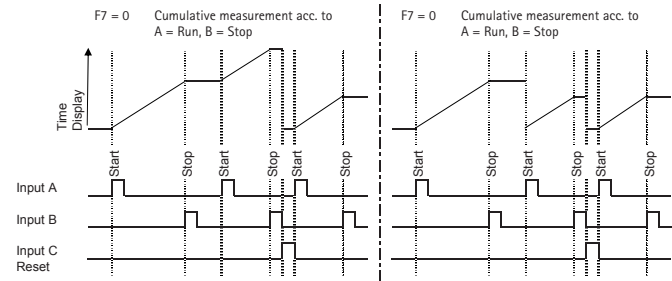



Timer



7.3 Signal Diagrams – Output signals

The output signals of the timer can be derived from the pulse counter (see 5.3) or, respectively, batch counter (see 9.2) functions.

7.4 Programming the Timer function codes

<p>Program- ming mode</p> <p>E + </p> <p>Keep pressed and simultaneously turn Voltage On</p>	<p>Change function setting</p> <p> oder </p> <p>press</p>	<p>Save and change to next function</p> <p></p> <p>press</p>	<p>Return to display mode</p> <p>E</p> <p>press</p>
<p>Alternative display of function codes</p>	<p> + </p>	<p>The function codes are displayed as text in row 1.</p> <p>By pressing both keys simultane- ously you can change to the numerical display (F 0 to F 35). After pressing these keys once again the number of the selecta- ble options will be displayed in addition. This setting will be stored.</p>	

Function code F0, Display Row 1: FEESEE

Function	No.	Display Row 2	
Factory Setting (Defaults)	0*	8.8.8.8.0	No function
	1	8.8.8.4E5	All function codes are set to the va- lues marked with *

Function code F1, Display Row 1: SEEE88

Time unit	0*	Seconds
	1	MM:MM:EE Minutes
	2	HH:MM:SS Hours
	3	HH:MM:SS HH:MM:SS

Function code F2, Display Row 1: E5008

Resolution	0*	No decimal point
	1	1 decimal place
	2	2 decimal places
	3	3 decimal places
	4	4 decimal places

Function code F3, Display Row 1: 1 0 P N L 0 0

PNP/NPN-Logic	0	0 P N L 0 0	NPN 8 V-Level
	1*	1 P N L 0 0	PNP 8 V-Level
	2	0 P N T L 0 0	NPN TTL-Level
	3	1 P N T L 0 0	PNP TTL-Level

Function code F4, Display Row 1: 1 0 A B A E E

Input damping (Attenuation)	0	0 0 0 F F 9	30 Hz damping (attenuation) (e.g. for mechanical contacts)
	1*	0 0 0 F F 9	F max. (see chapter 4 and 10)

Function code F5, Display Row 1: 1 5 S 0 0 0

Set / Re-set- Mode	0*	1 5 S 0 0 0	Reset to 0
	1	1 5 S 0 0 0	Automatic set to 0 after reaching Preset value 2
	2	1 5 E E P 2	Set to Preset 2
	3	1 5 E E P 2	Automatically sets to Preset 2 after reaching 0.

Function code F6, Display Row 1: 5 E S E E 0

dynam/static Reset	0*	5 E S E E 0	Static Reset (as long as the signal is applied)
	1	1 5 E E E 0	Dynamic Reset (ready to count after reset, even if reset signal is applied for a longer time)

Function code F7, Display Row 1: 1 E 0 N E F 0

Timer-Mode of Operation	0	1 E 0 P U L	Cumulative measurement - pulse-width (counts as long as Input A is active)
	1*	1 E 0 P E F	Cumulative measurement - cycle duration (counts from rising edge of start signal to rising edge of stop signal).
	2	1 E 0 F 0 5	Cumulative measurement - A=Run B=Stop (counts from rising edge of start signal to rising edge of stop signal).
	3	1 5 0 P U L	Single-pulse measurement - pulse-width (counts as long as Input A is active)
	4	1 5 0 P E F	Single-pulse measurement - cycle duration (counts from rising edge of start signal to rising edge of stop signal).
	5	1 5 0 F 0 5	Single-pulse measurement - A=Run B=Stop (counts from rising edge of start signal to rising edge of stop signal)

Function code F8, Display Row 1: P P E S 8 8

Mode Preset 1	0*	P P E S 8 8	P 1 normal preset; absolute to counter reading (coincidence signal)
	1	E P A 8 8 8	P 1 is a trail preset with prefix (relative to P 2)
	2	E P A 8 8 L S	P 1 as a symmetric trail preset (relative to P 2)
	3	P A R N G E 8	P 1 and P 2 are range signals (Sign.1<P1, Sign.2>P2)

Function code F9, Display Row 1: 0 0 E S 8 0

Output signal	0*	A 2 E 8 0 A	Active On
	1	A 2 E 8 0 F F	Active Off

Function code F10, Display Row 1: 5 1 0 8 8 0

Signal time P 0	0	8 8 5 A 8 0	Disabled / No output signal
	1	8 8 5 E A 8	Bistable, reset with Preset 2 or Reset
	2	8 8 8 0 0 2	0,02 s
	3	8 8 8 0 0 5	0,05 s
	4*	8 8 8 0 1 0	0,10 s
	5	8 8 8 0 2 0	0,20 s
	6	8 8 8 0 5 0	0,50 s
	7	8 8 8 1 0 0	1,00 s
	8	8 8 8 2 0 0	2,00 s
	9	8 8 8 5 0 0	5,00 s
	10	8 8 8 1 0 0 0	10,00 s
	11	U 5 E 8 8 1	User setting 1 (0-599,99 s)
	12	U 5 E 8 8 2	User setting 2 (0-599,99 s)
	13	U 5 E 8 8 3	User setting 3 (0-599,99 s)

Function code F11, Display Row 1:5108E1

Signal time P 1	0	888888	Disabled / no output signal
	1	888888	Bistable, reset with Preset 2 or Reset
	2	888002	0,02 s
	3	888005	0,05 s
	4*	888010	0,10 s
	5	888020	0,20 s
	6	888050	0,50 s
	7	888100	1,00 s
	8	888200	2,00 s
	9	888500	5,00 s
	10	8881000	10,00 s
	11	USEF88	User setting 1 (0-599,99 s)
	12	USEF82	User setting 2 (0-599,99 s)
	13	USEF83	User setting 3 (0-599,99 s)

Function code F12, Display Row 1:5108E2

Signal time P 2	0	888888	Disabled / No output signal
	1	888888	Bistable; Reset function cannot be used in connection with automatic Reset
	2	888002	0,02 s
	3	888005	0,05 s
	4*	888010	0,10 s
	5	888020	0,20 s
	6	888050	0,50 s
	7	888100	1,00 s
	8	888200	2,00 s
	9	888500	5,00 s
	10	8881000	10,00 s
	11	USEF88	User setting 1 (0-599,99 s)
	12	USEF82	User setting 2 (0-599,99 s)
	13	USEF83	User setting 3 (0-599,99 s)

Function code F13, Display Row 1: P 5 5 0 0

Stop after reaching the main Preset	0*	8888n0	No Stop when main Preset is reached (P 2)
	1	888yE5	Stop when main Preset is reached (P 2)

Function code F14, Display Row 1: F L A S H

Display flashes	0*	n0FLSH	no flashing
	1	8888P0	Flashes as long as P 0 is active
	2	8888P1	Flashes as long as P 1 is active
	3	8888P2	Flashes as long as P 2 is active
	4	P0-1-2	Flashes as long as 1 P is active

Function code F15, Display Row 1: 2. 0 L R A E

Display in 2nd Row	0	8888P0	Preset 0
	1	8888P1	Preset 1
	2*	8888P2	Preset 2
	3	888P50	Prescaler
	4	E0E6AE	Totalizer / Batchcounter

Function code F16, Display Row 1: 0 A R R 0 5 E

Start / Stop via Keyboard (manual)	0*	0ARR05E	Start / Stop locked via keys UP key=Start; DOWN key = Stop
	1	EARR05E	Start / Stop enabled via keys UP key =Start; DOWN key =Stop

Function code F17, Display Row 1: P 0 0 0 E 5

Power On Reset	0*	n000E5	Restore counter value
	1	888E5	Reset at Power On

Function code F18, Display Row 1: 0 U E N E N

Output Signal Memory	0	888yE5	Restart signal time after power fail  output switches
	1*	8888n0	Do not restart signal time after power fail

Function code F19, Display Row 1: 0 A d d 0 0 E

Addtl. Totalizer	0	888yE5	Enabled
	1*	8888n0	Disabled

Timer

Function code F20, Display Row 1: P F E S C L

Prescaler	0*	8 7 5 A B L	Prescaler not active
	1	E A B B L E	Prescaler active

Function code F21, Display Row 1: E I N E T P

Timer Type	0*	E I N E T P	Preset timer
	1	B A T C H P	Batch timer

Function code F22, Display Row 1: A P P L I N P

Application Output	0	P 0 0 0 0 E	Output Preset 0
	1*	R U N 0 0 0 0	Run-Input
	2	S T O P 0 0 0 0	Stop-Input
	3	R E S A L L	Reset counter and totalizer or batch counter
	4	R E S C A T E	Reset - only counter

Timer

	5	R E S B A T E	Reset - only totalizer or batch counter
	6	L O C K 0 0 0 0	Keylock input
	7	H O L D 0 0 0 0	Hold input (display memory)
	8	T E A C H 0 0 0 0	Teach Input (count value becomes P 2)
	9	S E T 0 0 0 0	Set Input (set to Preset 0)



Should you have a counter with interface, the additional function codes F24 - F27 are described in the separate manual for the interface version.

Function code F30, Display Row 1: F E S L O E

Lock Reset Key	0*	F E S L O E	Keyboard reset enabled
	1	F E S L O E	Keyboard reset locked / delayed

Function code F31, Display Row 1: P 0 S L O E

Lock Pre-set 0 Setting	0*	P 0 S L O E	P 0 Setting enabled
	1	P 0 S L O E	P 0 Setting locked / delayed

Function code F32, Display Row 1: P 1 8 8 0 0

Lock Pre-set 1 Setting	0*	8 8 0 0	P 1 Setting enabled
	1	8 8 8 0	P 1 Setting locked / delayed

Function code F33, Display Row 1: P 2 8 8 0 0

Lock Pre-set 2 Setting	0*	8 8 0 0	P 2 Setting enabled
	1	8 8 8 0	P 2 Setting locked / delayed

Function code F34, Display Row 1: P 5 0 0 0 0

Lock Prescaler Setting	0*	8 8 0 0	PSC Setting enabled
	1	8 8 8 0	PSC Setting locked / delayed

Function code F35, Display Row 1: 0 0 0 0 0 0

Lock Mode	0*	10 0 5 0 0	10 seconds delay
	1	8 0 0 0 0	Completely locked
	2	1 0 0 0 0	Lock mode depends on keylock input

8 Shift Counter

8.1 Shift Counter Description

(Supplementing the general description under chapter 4)

Function:

2-shift counters enable the acquisition of 2 separate partial sums. Counter input A acts on partial sum 1, whereas counter input B acts on partial sum 2.

Both partial sums are counted positively; the total sum is calculated mathematically and corresponds to the summed-up total (or respectively, the difference) of the partial sums.

The total sum remains unchanged after resetting one of the partial sums.

Counter mode of operation:

The following counter modes of operation can be selected:
Difference counting and summation (totalizing)

Output signals – mode of operation:

The counter operates in the "coincidence" mode, i.e. the output signals are enabled for the programmed period of time after reaching the selected Preset value.

The total sum acts on Preset 0

Partial sum 1 acts on Preset 1

Partial sum 2 acts on Preset 2

Reset:

After a reset at input C, both partial sums and the total sum are reset. When resetting via the application input it is possible to reset one or both of the partial sums or the total sum, depending on the selected programming. When resetting via the keyboard, only the value shown on the display is reset.

Totalizer:

The totalizer sums up all the input pulses, even if the partial sums and the total sum are reset. The totalizer can only be reset manually.

Shift Counter

8.2 Scrolling between Total Sum and Partial Sums

The Shift key is used to scroll between the total sum and partial sums 1 and 2.

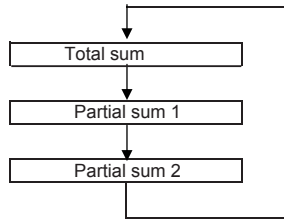

If a partial sum is shown, SU1 or SU2 will appear flashing in the lower display bar.

8.3 Signal diagrams - Inputs (PNP Logic)

Adding/Adding (F1= A A r)

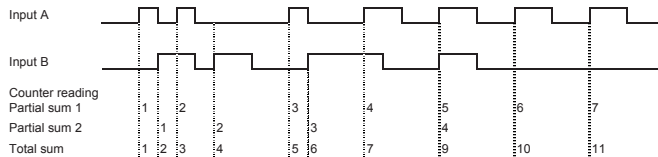

Shift Counter

Adding/Subtracting (F1= A S r)

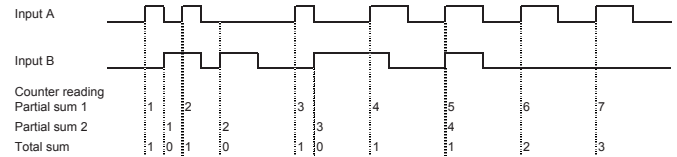

8.4 Signal Diagrams - Output signals





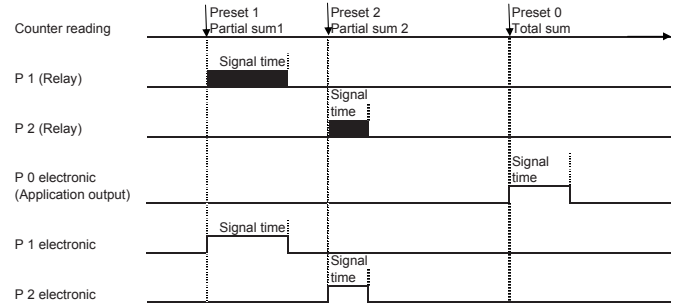

Output signals - monostable

Coincidence signals P 0/Total Sum (F10), P 1/Partial sum 1 (F11), P 2/Partial sum 2 (F12) monostable



Shift Counter

8.5 Programming the Shift Counter Function Codes

<p>Programming mode</p> <p>E + </p> <p>Keep pressed and simultaneously turn Voltage On</p>	<p>Change function setting</p> <p> or </p> <p>press</p>	<p>Save and change to next function</p> <p></p> <p>press</p>	<p>Return to display mode</p> <p>E</p> <p>press</p>
<p>Alternative display of Function codes</p> <p> + </p>	<p>The function codes are displayed as text in row 1. By pressing both keys simultaneously you can change to the numerical display (F 0 to F 35). After pressing these keys once again the number of the selectable options will be displayed in addition. This setting will be stored.</p>		

Function code F0, Display Row 1: F C E S E E

Function	No.	Display Row 2
Factory Setting (Defaults)	0*	8888n8 No function
	1	888yE5 All function codes are set to the values marked with *

Shift Counter

Function code F1, Display Row 1: C O U N T E R

Counter mode of Operation		Input A	Input B	Input C
0	8858f8	Adding	Subtracting	Reset
1*	8888f8	Adding	Adding	Reset

Function code F3, Display Row 1: I N P L O G

PNP/ NPN-Logic		
0	8888H8	NPN 8 V-Level
1*	8888H8	PNP 8 V-Level
2	8888L8	NPN TTL-Level
3	8888L8	PNP TTL-Level

Function code F4, Display Row 1: I n A B E E

Input Attenuat.		
0	8888f9	30 Hz damping (attenuation); e.g. for mechanical contacts
1*	8888f9	F max. (see chapter 4 and 10)

Shift Counter

Function code F5, Display Row 1: **PESEEE**

With / without Preset	0	8884E5	With Preset
	1*	8888n8	Without Preset

Function code F6, Display Row 1: **FESEEE**

Dynamic / static Reset	0*	5EAE88	Static reset (reset as long as signal is applied)
	1	d9n888	Dynamic Reset (ready to count after reset, even if reset signal is applied for a longer time)

Function code F9, Display Row 1: **00E510**

Output signal	0*	AEE80n	Active On
	1	AEE0FF	Active Off

Shift Counter

Function code F10, Display Row 1: **5100E0**

Signal time P 0	0	885A6L	Disabled / no output signal
Total Sum	1	615EAB	Bistable; reset with Reset
	2	888002	0,02 s
	3	888005	0,05 s
	4*	888010	0,10 s
	5	888020	0,20 s
	6	888050	0,50 s
	7	888100	1,00 s
	8	888200	2,00 s
	9	888500	5,00 s
	10	8881000	10,00 s
	11	USEF88	User setting 1 (0-599,99 s)
	12	USEF82	User setting 2 (0-599,99 s)
	13	USEF83	User setting 3 (0-599,99 s)

Shift Counter

Function code F11, Display Row 1:51 0888

Signal time P 1	0	88888888	Disabled / no output signal
Partial sum 1	1	8158888	Bistable; reset with Reset
	2	8888002	0,02 s
	3	8888005	0,05 s
	4*	8888010	0,10 s
	5	8888020	0,20 s
	6	8888050	0,50 s
	7	8888100	1,00 s
	8	8888200	2,00 s
	9	8888500	5,00 s
	10	88881000	10,00 s
	11	8588888	User setting 1 (0-599,99 s)
	12	8588882	User setting 2 (0-599,99 s)
	13	8588883	User setting 3 (0-599,99 s)

Shift Counter

Function code F12, Display Row 1:51 0888

Signal time P 2	0	88888888	Disabled / no output signal
Partial sum 2	1	8158888	Bistable; reset with Reset
	2	8888002	0,02 s
	3	8888005	0,05 s
	4*	8888010	0,10 s
	5	8888020	0,20 s
	6	8888050	0,50 s
	7	8888100	1,00 s
	8	8888200	2,00 s
	9	8888500	5,00 s
	10	88881000	10,00 s
	11	8588888	User-Einstellung 1 (0-599,99 s)
	12	8588882	User-Einstellung 2 (0-599,99 s)
	13	8588883	User-Einstellung 3 (0-599,99 s)

Shift Counter

Function code F13, Display Row 1: d P 0 0 0 0

Decimal Point	0*	8888.880	No decimal point
	1	8888.00	1 decimal place
	2	888.000	2 decimal places
	3	88.0000	3 decimal places
	4	8.00000	4 decimal places

Function code F14, Display Row 1: F F L S H

Display flashes	0*	0 F F L S H	No flashing
	1	8888.P0	Flashes as long as P 0 is active
	2	8888.P1	Flashes as long as P 1 is active
	3	8888.P2	Flashes as long as P 2 is active
	4	P0-1-2	Flashes as long as one Preset is active

Shift Counter

Function code F15, Display Row 1: 2.0000 E

Display in 2nd Row	0	8888.P0	Preset 0
	1	8888.P1	Preset 1
	2*	8888.P2	Preset 2
	3	888.P50	Prescaler
	4	888.S01	Partial sum 1
	5	888.S02	Partial sum 2
	6	888.E0E	Totalizer

Function code F17, Display Row 1: P 0 0 0 E S

Power-On Reset	0*	0 0 0 0 E S	Restores the counter value
	1	888.0 E S	Reset at Power On

Function code F18, Display Row 1: 0 0 0 0 E N

Output Signal Memory	0	888.4 E S	Restart signal time after power fail  output switches
	1*	8888.0 E	Do not restart signal time after power fail

Shift Counter

Function code F19, Display Row 1: A d d E o E

Adttl. Totalizer	0	8888 4 E 5	Additional totalizer is enabled
	1*	8888 0 0	No additional totalizer

Function code F22, Display Row 1: A P P E I N P

Application Input/Output	0	P 0 8 0 0 E	Output Preset value 0
	1*	A 2 8 8 0 P	2nd counter input partial sum 1
	2	6 2 8 8 0 P	2nd counter input partial sum 2
	3	8 E 5 8 5 1	Reset of partial sum 1
	4	8 E 5 8 5 2	Reset of partial sum 2
	5	8 E 5 5 1 2	Reset of both partial sums
	6	8 E 5 8 8 E	Reset of total sum
	7	H 0 L d 8 8	Hold Input (display memory)
	9	L 0 0 8 8 8	Keylock Input

Shift Counter



Should you have a counter with interface, the additional function codes F24 - F27 are described in the separate manual for the interface version.

Function code F30, Display Row 1: E S L 0 E

Lock Reset key	0*	8 0 n L 0 E	Keyboard reset enabled
	1	8 8 8 L 0 E	Keyboard reset locked / delayed

Function code F31, Display Row 1: P 0 8 L 0 E

Lock Preset 0	0*	8 0 n L 0 E	P 0 Setting enabled
	1	8 8 8 L 0 E	P 0 Setting locked / delayed

Function code F32, Display Row 1: P 1 8 L 0 E

Lock Preset 1	0*	8 0 n L 0 E	P 1 Setting enabled
	1	8 8 8 L 0 E	P 1 Setting locked / delayed

Function code F33, Display Row 1: P 2 L O C E

Lock Preset 2	0*	8 8 8 8 L O C E	P 2 Setting enabled
	1	8 8 8 8 L O C E	P 2 Setting locked / delayed

Function code F34, Display Row 1: P 5 C L O C E

Lock Prescaler Setting	0*	8 8 8 8 L O C E	PSC Setting enabled
	1	8 8 8 8 L O C E	PSC Setting locked / delayed

Function code F35, Display Row 1: L O C b A R E

Lock Mode	0*	1 0 8 5 E E	10 seconds delay
	1	8 L O C E L d	Completely locked
	2	1 8 P L O C E	Lock mode depends on keylock input

9 Batch Counter

9.1 Batch Counter Description

(Supplementing the general description in Chapter 4)

Function:

Preset 2 is the main Preset setting.

Preset 1 is the Batch Preset or, respectively, the preset value of the 2nd totalizer.

In the batch operation the batch counter counts how often the main Preset is activated.

Example of an application: during length cutting operations, for example, both the lengths (main preset) and number (batch preset) can be monitored.

In the Batch mode of operation, only positive entries are possible for P1; negative entries will be stored as positive values.

Counter mode of operation:

The following modes of operation can be adjusted for the counter:

- Unidirectional counting, adding or subtracting;
- Unidirectional counting with directional input;
- Difference counting, summation and phase discrimination (quad) with single, double or quadruple evaluation.

Output signals Mode of Operation:

The counter operates in the coincidence mode, i.e. the output signals are enabled for the programmed duration when the selected preset value is reached.

Prescaler Output PSC-out:

The Prescaler output is an application output.

With each increase of the counter reading the number of output pulses corresponds to the respective number of increments.

The pulse length of the prescaler output corresponds to a frequency of 500 Hz.

When using the prescaler output the max. input frequency is:

$$F_{\max} = 500 / PSC.$$

So it is possible that the maximum input frequency can not be reached.

9.2 Signal Diagrams – Inputs and Outputs

Unidirectional count (F1 = C G r), Batch counter (F19 = bAtch),
 Preset 2 (Main Preset = 5, Preset 1 (Batch Preset) = 3

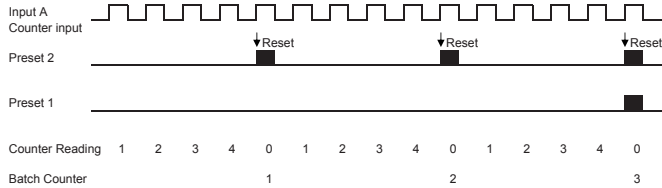

9.3 Programming the Batch Counter Function Codes

Programming mode	Change function setting	Save and change to next function	Return to display mode
Keep pressed and simultaneously turn Voltage On	press	press	press
Alternative display of Function codes		The function codes are displayed as text in row 1. By pressing both keys simultaneously you can change to the numerical display (F 0 to F 35). After pressing these keys once again the number of the selectable options will be displayed in addition. This setting will be stored.	

Function code F0, Display Row 1: F 0 E E E E

Function No. Display Row 2

Factory Setting (Defaults)	0*	8888 00	No function
	1	888 4 E 5	All function codes are set to the values marked with *

Function code F1, Display Row 1: C O U N T E R

Counter Mode of Operation	Input A	Input B	Input C
0*	Count Input	Gate	Reset
1	Count Input	Directional input	Reset
2	Count Input	Directional input	Gate
3	Adding	Subtracting	Reset
4	Adding	Subtracting	Gate
5	Adding	Adding	Reset
6	Channel A	Channel B	Reset
7	Channel A	Channel B	Gate

Batch Counter

Function code F2, Display Row 1: **900000**

Edge Evaluation	0*	888888	Single evaluation
Quadrat. Evaluation	1	888882	Double evaluation
	2	888884	Quadruple evaluation

Function code F3, Display Row 1: **100000**

PNP/ NPN-Logic	0	000000	NPN 8 V-Level
	1*	000000	PNP 8 V-Level
	2	000000	NPN TTL-Level
	3	000000	PNP TTL-Level

Function code F4, Display Row 1: **100000**

Input damping (Attenuat)	0	000000	30 Hz damping (e.g. for mechanical contacts)
	1*	000000	F max. (see chapter 4 and 10)

Batch Counter

Function code F5, Display Row 1: **550000**

Set / Re-set- Mode	0*	000000	Reset to 0
	1	000000	Automatic reset to 0 when Preset value 2 is reached
	2	500000	Sets to Preset value 2
	3	000000	Automatic set to Preset 2 after reaching 0

Function code F6, Display Row 1: **550000**

Dynamic/ static Reset	0*	500000	Static Reset (reset as long signal is applied)
	1	000000	Dynamic Reset (ready to count after reset, even if reset signal is applied for a longer time)

Function code F9, Display Row 1: **000000**

Output signal	0*	000000	Active On
	1	000000	Active Off

Batch Counter

Function code F10, Display Row 1:510880

Signal time P 0	0	885860	Disabled / no output signal
	1	885886	Bistable; reset with Preset 2 or Reset
	2	888002	0,02 s
	3	888005	0,05 s
	4*	888010	0,10 s
	5	888020	0,20 s
	6	888050	0,50 s
	7	888100	1,00 s
	8	888200	2,00 s
	9	888500	5,00 s
	10	8881000	10,00 s
	11	USEF881	User-setting 1 (0-599,99 s)
	12	USEF882	User-setting 2 (0-599,99 s)
	13	USEF883	User-setting 3 (0-599,99 s)

Batch Counter

Function code F11, Display Row 1:510881

Signal time P 1	0	885860	Disabled / no output signal
Batch-Preset	1	885886	Bistable; reset with Reset
	2	888002	0,02 s
	3	888005	0,05 s
	4*	888010	0,10 s
	5	888020	0,20 s
	6	888050	0,50 s
	7	888100	1,00 s
	8	888200	2,00 s
	9	888500	5,00 s
	10	8881000	10,00 s
	11	USEF881	User-setting 1 (0-599,99 s)
	12	USEF882	User-setting 2 (0-599,99 s)
	13	USEF883	User-setting 3 (0-599,99 s)

Function code F12, Display Row 1: 5.0002

Signal time P 2	0	8.8.8.8.00	Disabled / no output signal
	1	8.8.8.8.88	Bistable; reset with Reset Cannot be used in connection with automatic Reset
	2	8.8.8.0.02	0,02 s
	3	8.8.8.0.05	0,05 s
	4*	8.8.8.0.10	0,10 s
	5	8.8.8.0.20	0,20 s
	6	8.8.8.0.50	0,50 s
	7	8.8.8.1.00	1,00 s
	8	8.8.8.2.00	2,00 s
	9	8.8.8.5.00	5,00 s
	10	8.8.8.10.00	10,00 s
	11	U5E8.8.8	User-setting 1 (0-599,99 s)
	12	U5E8.8.2	User-setting 2 (0-599,99 s)
	13	U5E8.8.3	User-setting 3 (0-599,99 s)

Function code F13, Display Row 1: 8.8.8.8.00

Decimal point	0*	8.8.8.8.00	No decimal point
	1	8.8.8.8.00	1 decimal place
	2	8.8.8.0.00	2 decimal places
	3	8.8.0.0.00	3 decimal places
	4	8.0.0.0.00	4 decimal places

Function code F14, Display Row 1: 8.FLASH

Display flashes	0*	8.FLASH	No flashing
	1	8.8.8.8.P0	Flashes as long as P 0 is active
	2	8.8.8.8.P1	Flashes as long as P 1 is active
	3	8.8.8.8.P2	Flashes as long as P 2 is active
	4	P0-1-2	Flashes as long as one Preset is active

Batch Counter

Function code F15, Display Row 1:2.0000E

Display in 2nd row	0	0000P0	Preset 0
	1	0000P1	Preset 1
	2*	0000P2	Preset 2
	3	000P50	Prescaler
	4	6AE020	Batch counter or 2nd counter

Function code F16, Display Row 1:E000E58

External Reset signal	0	0E50AE	Only resets the counter
	1	0E56AE	Only resets the batch counter
	2*	0E5A00	Resets all counters

Batch Counter

Function code F17, Display Row 1:P000E5

Power On Reset	0*	0000E5	Restores the counter value
	1	0000E5	Reset at Power On

Function code F18, Display Row 1:0000E0

Output signal-Memory	0	0000E5	Restart signal time after power fail  output switches
	1*	0000E0	Do not restart signal time after power fail

Function code F19, Display Row 1:6AE2HE

Batch-Counter or 2nd totalizer	0*	6AE2HE	Batch counter
	1	2000E0	2nd totalizer

Function code F22, Display Row 1:AP010P

Application input/output	0	P5000E	Prescaler output
	1	P0000E	Output Preset 0

Batch Counter

2		Directional count output
3*		Count input, adding
4		Count input, subtracting
5		Reset counter and Batch counter or 2nd totalizer
6		Resets only counter
7		Resets only Batch counter or 2nd totalizer
8		Gate input
9		Keylock input
10		Hold input (display memory)
11		Teach input Count value becomes P 2
12		Set-input (sets to Preset 0)

Batch Counter



Should you have a counter with interface, the additional function codes F24 - F27 are described in the separate manual for the interface version.

Function code F30, Display Row 1:

Lock Re-set key	0*		Keyboard reset enabled
	1		Keyboard reset locked / delayed

Function code F31, Display Row 1:

Lock Preset 0 Setting	0*		P 0 Setting enabled
	1		P 0 Setting locked / delayed

Function code F32, Display Row 1:

Lock Preset 1 Setting	0*		P 1 Setting enabled
	1		P 1 Setting locked / delayed

Function code F33, Display Row 1: P 2 8 8 8 8

Lock Preset 2 Setting	0*	8 0 8 8 8 8	P 2 Setting enabled
	1	8 8 8 8 8 8	P 2 Setting locked / delayed

Function code F34, Display Row 1: P 5 8 8 8 8

Lock Prescaler Setting	0*	8 0 8 8 8 8	PSC Setting enabled
	1	8 8 8 8 8 8	PSC Setting locked / delayed

Function code F35, Display Row 1: 1 0 8 8 8 8

Lock Mode	0*	1 0 8 8 8 8	10 seconds delay
	1	8 8 8 8 8 8	Completely locked
	2	1 1 8 8 8 8	Lock mode depends on Keylock input

10 Technical Data

General

Display	LCD reflective, Transflective positiv: black figures on back lighted ground Transmissive negativ: white, red or green figures on black ground 2 lines, counter reading/presettings 6-digits; decimal point (up to 4 decimals)
Digit height	1st line 9.3 mm; 2nd line 7.2 mm
View angle	12 o'clock
Supply voltage	SELV: 12-30 VDC; protected against polarity reversal SELV: 24 VAC, 50/60 Hz, ± 10% 115 VAC; 230 VAC, 50/60 Hz, ± 10% 100-240 VAC; 50/60 Hz, ± 10%
Current consumption	12 ... 30 VDC < 200 mA, 12 - 30 VDC with backlight < 250 mA incl. sensor supply 24 VAC < 250 mA; including sensor supply 115/230 VAC < 50 mA; incl. sensor supply 100 - 240 VAC < 80 mA at 90 VAC; incl. sensor supply
Power consumption	< 5 W < 8 W switching power supply
Duty cycle	100%
Overload protection	external fuse DC: 0,16 AT (IEC 127); DC: 0,2 AT (UL 198) 24 VAC: 315 mA T; 230 VAC: 32 mA T; 115 VAC: 63 mA T 100 - 240 VAC G-safety insert 630 mA/250V
Overload protection Relay output	external fuse 230 V, 2,5 A mT
Sensor supply	24/115/230 VAC AC-operation: 12-24 VDC (load dependent), max. 50 mA 90-260 VAC (switching power supply) AC-operation: 24VDC/-5%, max. 115 mA max. capacitive load = 470 µF

Technical Data

Storage of values	NV-memory > 10 years
Electrical connections	Plug-in screw-type connections / Terminals
Cable cross-section	1...1.5 mm ² with wire-end sleeves
Amplitude threshold	< 2 V and > 8 V or < 1 V and > 4 V at TTL-level amplitude max. 40 VDC
Active edge	programmable positive for PNP-input, negativ for NPN-input
Input resistance	approx. 10 kOhm
Count frequency	max. 60 kHz (TTL 20 kHz): single-channel counting max. 60 kHz (TTL 20 kHz): Different. counting and totalizing channel (A+B together) max. 30 kHz (TTL 20 kHz): phase discriminator single or double evaluation max. 15 kHz (TTL 15 kHz): phase discriminator, quadruple evaluation
	 damped (attenuated) 30 Hz -> <i>Please pay attention to graphics on page 117</i>
Pulse form	any desired form (at max. frequency square 1:1)
Pulse duration min	17 ms (30 Hz); 8 µs (60 kHz)
Prescaler	0,0001 - 99,9999
Reset	manual reset via keyboard external reset static or dynamic programmable pulse length min. 5 ms, automatic reset after reaching Preset 2, (No pulse losses at max. counter frequency due to automatic reset function). via application input (programmable) and programmable Power-On Reset
Set function	Setting to Preset 0 (independent of reset)
Display and Preset Range	- 999 999 up to + 999 999

Technical Data

Warning signal	Display flashes when preset 0, 1 or 2 are active
Signal times	0,01 s to 599,99 s or bistable programmable tolerance + 10ms active On or Off
Relay Output for P 1 and P 2	Change-over contact max. 250 VAC / 30 VDC / 5 A Change-over contact min. 5 VAC / 5 VDC / 10 mA delay < 10 ms
Transistor Output for P 1 and P 2	PNP-output 12 - 30 VDC max. 50 mA at DC-supply 12 - 24 VDC max. 30 mA at AC-supply (24/115/230 VAC) 24 VDC, max 50 mA at AC-supply with switching power supply
Application Output	PNP-output 12 - 30 VDC max. 20 mA at DC supply 12 - 24 VDC max. 20 mA at AC supply (24/115/230 VAC) 24 VDC max. 20 mA at AC-supply with switching power supply



Only for trafo-power-supply:
Current load of the outputs (Sensor 12-24 VDC, Out 1, Out 2, Application-Output) is not allowed to exceed 65 mA in sum.

Counter

Counter mode of operation Input A,B	Unidirectional; adding or subtracting; directional input; Differential operation, add / sub; Summation (Totalizing) add / add; Phase discriminator single, double or quadruple evaluation
Control Input	Reset; Gate
Preselect Mode	Absolute or trail, Range signal /limit values (sign. 1 < P1, sign. 2 > P 2)
Application Input/Output	Output: Prescaler-out, Preset 0-out, Direction-out Input: addtl. counter input add / sub, Reset, Set, Gate, Keylock, Hold, Teach in

Technical Data

Batch Counter

Mode	Batch counter with Preset or 2nd totalizer with Preset
------	--------------------------------------------------------

Shift Counter

Counter Mode of Operation	Differential counting add/sub, totalizing add/add
---------------------------	---------------------------------------------------

Tachometer

Measuring Principle	Period (cycle) measurement (1/Tau)
Time base	1/min or 1/s
Min. frequency	1 Hz or 0,1 Hz
Limit values pression	2 alarms with programmable startup sup +1 additional upper limit value on the application output
Tachometer mode of operation	Unidirectional add oder sub; directional input;Differential add / sub; totalizing add / add; Phase discriminator single, double or quadruple evaluation, A / B or (A-B) / A %
Application Input/Output	Output: Preselect 0-out, Direction-out Input: addtl. counter input add / sub, Keylock, Hold, Teach in
Accuracy of the tachometer function	Time base: ± 30 ppm Measuring principle: Periodic measurement Measuring time: min. 0,5s / max. 1s oder 10s Measuring resolution: 0,4 μ s(<30 ppm) Display resolution: 4 decimal places, 1 Digit = 100 ppm
Overall tolerance	= Shown resolution + tolerance of timebase = 130 ppm

Technical Data

Timer

Measuring Principle	Pulse-width or cycle duration measurement Start Inp. A + Stop Inp. B; Start/Stop key
Time base	Programmable in sec, min, h or hh.mm.ss
Resolution	1; 0,1; 0,01; 0,001; 0,0001
Function	Single-pulse or cumulative measurement
Application In- put/Output	Output: Preselect 0-out Input: addtl. Run, Stop, Reset, Set, Keylock, Hold, Teach in
Accuracy of the timer	Time base: ± 30 ppm Start / Stop-point in time: 16 μ s / 16 ms (not damped / damped) Resolution: 100 μ s = 100 ppm
Overall tolerance	= Shown resolution + tolerance of timebase = 130 ppm

Environmental conditions / Safety Rules

General design	EN 61010-1 / IEC 61010-1
Protection Class	II; EN 61010-1 / IEC 61010-1
Pollution degree	V 2, EN 50178
EMC - Interference immunity	EN 61326-1 industrial environment *
EMC - Emission	EN 61326-1 Class B *
Ambient tem- perature	0°... 50°C EN 60 068-2-1/2 0°... 45°C with block assembly 0°... 50°C in single row assembly
Storage tem- perature	- 20°... + 65°C EN 60 068-2-1/2
Climate	40°C / 93% rel hum. class 4K4H, EN 60 068-2-78 25 - 50°C / 93% rel hum., cyclic, EN 60 068-2-38
Altitude	up to 2000m

Technical Data

Degree of protection	IP 65 front side; EN 60529 IP 20 terminals
Vibration resistance	10 m/s ² (10 ... 150 Hz); EN 60 068-2-6
Shock resistance	100 m/s ² (18 ms); EN 60 068-2-27
Resistance to chemicals	Frontfoil acc. to DIN 42 115-2
Approvals	UL, CSA: E 338588
RoHS	compliant

Mechanical Data

Installation	Front-panel installation with tenter (frame) Front panel thickness max. 11 mm
Dimensions	48 mm x 48 mm x 118 mm, installation depth 110 mm DIN 43700
Front-panel cutout	45 mm x 45 mm + 0,3 mm
Weight	approx. 200 g

* For cable length > 30 m, for connection to a DC-supply-network and input level TTL an additional protection circuit is necessary.

Technical Data

Counting frequency according to signal voltage – Tico 77x

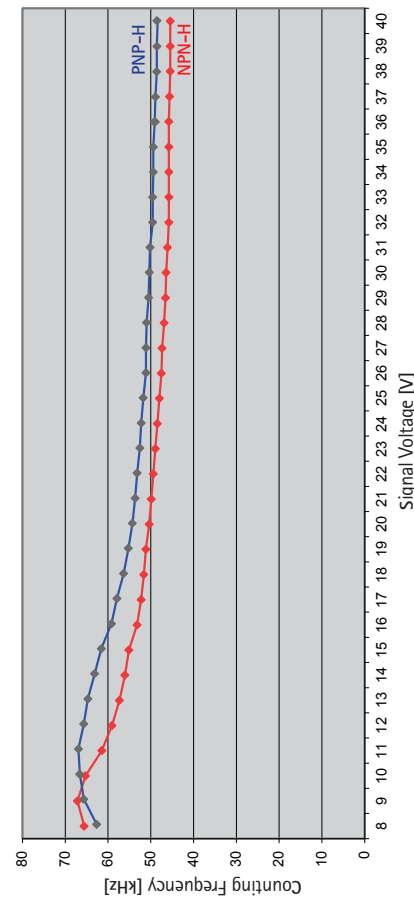

The counting frequencies were determined by using a signal generator with an output resistance of 50 Ω.

11 Transport, Packaging, Storage



Note! Damage may be caused by improper transport! Improper transport may cause considerable damage. Do not remove the packaging before assembly and installation.

The packaging offers ideal protection against mechanical damage and loss of single parts, such as the plugs or operating instructions. Therefore, do not take the multifunctional counter out of its packaging until you actually have to start your assembly and installation work.

Inspect the shipment for completeness and possible signs of transport damage immediately after receipt.

12 Maintenance and cleaning

The multifunctional counter does not require any maintenance.

The front side may be cleaned with commercially available household detergents.

For protection against pollution, a transparent, flexible protection cover is available as accessory (see chapter 17). With this protection cover, the counter display can be read and the buttons can be used.

13 Malfunctions



Warning!
Danger of injuries due to improper fault correction! Improper fault correction may cause serious damage or personal injury.

The machine/plant manufacturer is responsible for the preparation of operating instructions or a description stating the potential errors and the appropriate corrective action, as well as potential hazards and the behavior in the event of malfunctions. This is dependent on the design concept and construction of the machine or plant.

The first step is to determine if the cause of an error or malfunction implies a possible fault of the multifunction counter.

Overview of Errors

Error	Possible cause	To be corrected by:
Display remains dark	Machine/plant not powered on	Operator
	Defective voltage supply	Qualified electrician
Value is not stored	Power-on reset is active (F17)	Skilled personnel
Counter/tachometer does not count	Defective signal generator; Counter does not receive any counting signals	Skilled personnel
	Adjusted to incorrect mode of operation (F1), Single-channel, directional input, differential counting, phase discriminator	Skilled personnel
	Incorrect adjustment of PNP/NPN logic and input level (F3)	Skilled personnel

Malfunctions

	High-level does not exceed the upper amplitude threshold; low-level does not fall below the lower amplitude threshold	Qualified electrician
	Continuous reset signal is applied	Qualified electrician
	Continuous gate signal is applied	Qualified electrician
Incorrect counting of counter/tachometer	Prescaler value is not correct	Skilled personnel
	Phase discriminator - edge evaluation not correctly adjusted (F2)	Skilled personnel
	Input frequency too high (F4)	Skilled personnel
Keyboard Reset not possible	Keys are locked (F30 + F35)	Skilled personnel
Presetting not possible	Keys are locked (F31, F32, F33 + F35)	Skilled personnel
	Prescaler adjustment not possible	Keys are locked (F34+ F35)
Signal 0, 1 or 2 not received	Signal deactivated (F10, F11, F12)	Skilled personnel
	User signal time adjusted to 0,000	Skilled personnel

Spare Parts / Dismantling and Disposal

14 Spare Parts



Warning!

Danger due to faulty spare parts!

The use of incorrect or faulty spare parts may cause damage, malfunction or even total breakdown and safety hazards. Therefore, please make sure only to use the original spare parts provided by the manufacturer.

The multifunctional counter may only be opened by the manufacturer. Exclusively outer components are available as spare parts.

The order numbers are given in Chapter 17.

15 Dismantling and Disposal

After reaching the end of its useful life the multifunctional counter has to be disposed of or recycled according to the applicable environmental protection rules.

Ordering Information

16 Ordering Information

Display LCD	Relay	12-30 VDC	24 VAC	115 VAC	230 VAC	100-240 VAC
reflective	1	0 772 101	0 772 111	0 772 121	0 772 131	0 772 141
reflective	2	0 772 102	0 772 112	0 772 122	0 772 132	0 772 142
transflective positive	1	0 772 201	-	-	-	0 772 241
transflective positive	2	0 772 202	-	-	-	0 772 242
transmissive white	1	0 772 301	-	-	-	0 772 341
transmissive white	2	0 772 302	-	-	-	0 772 342
transmissive red	1	0 772 401	-	-	-	0 772 441
transmissive red	2	0 772 402	-	-	-	0 772 442
transmissive green	1	0 772 501	-	-	-	0 772 541
transmissive green	2	0 772 502	-	-	-	0 772 542

Reflective: black figures on bright reflecting background

Transflective positive: black figures on back lighted ground

Transmissive white: white figures on black ground

Transmissive red: red figures on black ground

Transmissive green: green figures on black ground

Accessories

17 Accessories

Adapter front panel

Order no.	Dimensions	Front panel cutout
1 405 675	60 x 75 mm	55 x 55 mm
1 405 676	72 x 72 mm	68 x 68 mm
1 405 679	125 x 60 mm	106 x 55 mm for installation of 2 counters 48 x 48
protection cover	2 772 052	
(tenter) frame	1 721 004	48 x 48 mm

Version: 1 200213 HF1



2772083

HENGSTLER

Hengstler GmbH | Uhlandstr. 49 | 78554 Aldingen

Telefon +49 (0) 7424-890 | info@hengstler.com

www.hengstler.com